

Manual on Hazard Resistant Construction in India

For reducing vulnerability in
buildings built without engineers



**Manual on
Hazard Resistant Construction in India**
For reducing vulnerability in buildings built without engineers

June 2008

Prepared by Rajendra Desai and Rupal Desai
With the support from NCPDP team under GOI-UNDP DRM Programme

National Centre For People's - Action In Disaster Preparedness. (NCPDP)
103,"Antariksh Building" Panjarapole Cross Roads, Vikram Sarabhai Marg,
Ahmedabad - 380 015.Gujarat - (India) Tel : 079 - 26300970, Fax : 079 - 2630 8843.
Email : mitigation@ncdpindia.org, Website : ncpdpindia.org

The use and sharing of information contained in this document is encouraged, with due acknowledgment of the source.

All Photographs © NCPDP, 2007, UNDP license for the use of the photographs allows reproduction of the images as part of this publication only, and not independently.

The views expressed in this document are those of the authors. They do not necessarily represent those of the Ministry of Home Affairs (MHA) or United Nations Development Programme (UNDP) or any other part of the United Nations system.

The designations employed and the presentation of material throughout this publication do not imply the expression of any opinion whatsoever on the part of UNDP concerning the legal or development status of any country, city or area or of its authorities or concerning the delimitation of its frontiers or boundaries.

Preface

Natural phenomena like earthquake and cyclones become disasters because of lack of awareness on how to construct affordable disaster resistant houses by using viable technologies. It has been observed that this ignorance results in the violation of the basic rules of good construction and hazard resistant technology leading to deaths, injury and unwarranted hardship to the people along with huge losses in terms of houses and infrastructure. In addition to the direct losses caused by the disaster it has been observed that the people suffer self-inflicted losses out of ignorance and under the influence of the unscientific myths that prevail after the disasters. For example the Latur Earthquake made people think that there was no future in their houses that were built out of stone, wood and mud, or those with foundation built on soil instead of on rock, or those that were made with load-bearing system. This led them to get their houses dismantled and sell the salvaged material at a throw away price. As a result tens of thousands of families lost perfectly good undamaged houses.

This manual focuses on construction of hazard resistant masonry buildings as well as restoration and retrofitting of the existing masonry buildings. It has been observed that even RCC construction is also often done in a non-engineered manner. Hence, some basic but critical information is provided on RCC construction also. Since the manual is meant to guide contractors, masons and house-owners, a maximum possible use of visuals including photographs of actual construction has been made with text included where required. The manual is based on various codes and guidelines of Bureau of Indian Standards and is linked to the Vulnerability Atlas made by Ministry of Housing and Urban Poverty Alleviation, Govt. In addition the practical experience of the authors for the past one and a half decades in retrofitting of hundreds of vernacular structures as well as in construction of new houses applying hazard resistant technology with local materials in widely differing regions of the country has provided a sound footing in the preparation of this manual.

It should be noted that the list of rules and measures given in this manual is not exhaustive. But the most critical rules are covered. The measures given here cover the most common types of buildings in the country. The understanding of the underlying principles should help the reader to evolve measures for other situations.

Since there are great variations in the construction practice of masonry structures in different parts of the country, some of the important regional variations are also included in the manual to enable the house owner and the masons to relate to various measures in reference to the locally used construction methods.

The information provided in this manual is essentially for the higher risk areas including Seismic Zones III, IV and V, Wind Speed Zones III and IV with wind speeds ranging from 47 to 55m./second, and the areas affected by the floods. But the people in the other zones also could refer to it for guidance.

The manual has evolved to be comprehensive on account of the reasons indicated above. It is expected that masons will be initiated in the use of this manual as a part of a training program so that they get the maximum benefit out of the Manual. Once the training is completed this Manual can be used as a reference book to be used as often as required. This manual is equally useful to the site supervisors, engineers, and by those wanting to get their house built by a mason. We earnestly hope that they too would make use of this manual.

Finally, it is intended that this manual will help in reducing the undue losses and hardships to the people when struck by an earthquake, cyclone or a flood, and that it becomes an important tool in making India less vulnerable to disasters.

FOREWORD

The primary objective of GOI-UNDP Disaster Risk Management programme (DRM) being implemented across 169 multi hazard prone districts in 17 states is sustainable reduction in disaster risk through capacity building of different stakeholders. In order to meet this objective several training programmes have been carried out for the engineers, architects and masons/artisans in different cities covered under Urban Earthquake Vulnerability Reduction Project (UEVRP) as well as in the districts targeted under Disaster Risk Management Programme on hazard resistant construction.

Studies carried out by the authors of this manual in the aftermath of the various disasters in the past fifteen years have brought out one major fact that the death and destruction that occurred during these disasters are primarily due to collapse of buildings and houses which were not constructed on the principles of hazard resistant construction. Under the impact of the natural forces such generated by earthquakes, floods, cyclones the vulnerable buildings collapse and cause death of innocent people and many a times it has been observed that such collapses take place due to ignorance about the right methods of construction.

In rural areas of India as well as in the semi urban pockets a major part of the housing construction is undertaken with the help of local masons without any intervention of the engineers. These masons are usually trained in an informal way and begin their career as assistants to senior masons. The capacity of such masons depends on the skills of senior masons. It has been observed that most of them do not possess the required capacity to build hazard resistant buildings, which is evident from the devastation in Latur, Uttarkashi, Chamoli and Bhuj earthquake and Orissa super cyclone. Therefore, the priority of the masons' training programmes conducted under the Disaster Risk Management Programme has been on skill upgradation of practicing masons through appropriate hands-on training.

This manual can be used as a ready reference by the trained masons and will also be equally helpful for the site supervisors, engineers and homeowners who want their houses to be built by masons. The manual will be translated in regional languages to reach out to the target groups at the local level.

The masons will be introduced and exposed to this manual by their trainer. The information provided in this manual cover three major hazards ie Earthquakes, floods and cyclones. The manual mentions all the necessary construction codes to be followed in order to ensure structural safety in seismic zone III, IV and V, in wind speed zones III and IV with a wind speed of 47 to 55 km /hour and the areas prone to floods. The manual throws light on the critical aspects to be followed in new construction that are commonly violated. Appropriate visuals have been used to make this manual user-friendly. In the section on restoration of damage and retrofitting of existing buildings every important aspect has been covered step by step using visuals. For greater emphasis the right and wrong are indicated by bright red symbols.

It is expected that this joint effort of Ministry Of Home Affairs, GOI and UNDP in bringing out this manual for on hazard resistant construction practices in India will contribute towards ensuring structural safety and development of safer built environment in India.



Pieter Bult
Deputy Country Director
United Nations Development Programme
New Delhi



Rajiv Kumar
Director
Ministry of Home Affairs, Government of India
New Delhi

ACKNOWLEDGEMENTS

First and foremost we the authors appreciate this initiative taken up under GOI-UNDP Disaster Risk Management Programme. This manual was accomplished under the guidance and constant support from senior officials of Ministry Of Home Affairs, Mr. Sushil Kumar, Assistant Country Director, UNDP and Mr. G. Padmanabhan, Emergency Analyst, UNDP. As always the technical guidance and constructive comments from Shri Anand Swaroop Arya, National Seismic Advisor, Ministry Of Home Affairs, has been crucial in ensuring completeness in the manual and in bringing credibility and value to the manual. A word of thanks is also due to Ms. Ranjini Mukherjee, Mr. Sushil Chaudhary and Ms. Shafali Rajora for providing all necessary support required to complete this manual

Relevant Building Codes & Guidelines of Bureau of Indian Standards as well as the Government Technical Guidelines for disaster resistant building construction prepared in the aftermath of various disasters form the basis for this manual. On the other hand two decades of our work in the field of building technologies through field demonstrations and onsite training of masons and engineers, coupled with community awareness programs form the backbone of this manual. In addition it is backed by a large number of manuals and public awareness materials that we have produced in five different languages of India for as many regions.

In much of our disaster mitigation related field work we have had good fortune of associating with a few pioneers in this field including Retd. Prof.A.S.Arya of IIT Roorkee and Retd. Prof. K.S. Jagadish of IISC Bangalore. Their input always brought in sound engineering to our work dictated by the practical considerations of field.

Through out these years of working with the building artisans, the artisans themselves have been the principal source of learning, especially from the immense pool of vernacular knowledge . It has been only these artisans that have kept our hopes of vulnerability reduction through bringing improvements in the non-engineered building scenario alive. The culmination of these feelings was experienced in our work with 28 master masons in the Uri Region of Kashmir in the summer of year 2006.

Among those that we have been closely working with we must acknowledge the valuable support that we got from Ajay Madhwani, Harshad Talpada and Ajay Kankrecha of the NCPDP team in putting together this document, Shri B.J. Karani in doing meticulous proof reading as well as review as a non-technical person, and finally Shri Dinkar Shah in providing guidance in the chapter on RCC.

All our work with building technology had been accompanied by extensive photographic documentation with a sole objective of sharing the experience with others. As a result all the photographs used in this manual have been selected out of our own collection.

Rupal Desai and Rajendra Desai
Ahmedabad, GUJ.

ABBREVIATIONS

WORDS	Abbreviations
AC	Asbestos cement
Approx.	Approximately
BBCM	Burnt brick in cement mortar
BBMM	Burnt brick in mud mortar
BMTPC	Building Material Technology Promotion Council
Cem.	Cement
CGI	Corrugated galvanized iron
CM	Cement mortar
cm	Centimeter
Cum.	Cubic meter
CWM	Chicken wire mesh
Dia.	Diameter
Dist.	Distance
Eqk.	Earthquake
ga.	Gauge
Horz.	Horizontal
kg.	Kilogram
km.	Kilometer
Lt	Litre
m	Meter
Max.	Maximum
Min.	Minimum
mm	Milli meter
MS	Mild steel
NCPDP	National Center of Peoples'- Action in Disaster Preparedness
NDMD	National Disaster Management Division
No. / no.	Number
RC	Reinforced concrete
RCC	Reinforced cement concrete
RRM	Random rubble masonry
Rmt.	Running meter
Smt.	Square meter
Sq.m.	Square meter
UCRC	Un-coursed rubble masonry in cement mortar
UCRM	Un-coursed rubble masonry in mud mortar
UNDP	United Nations Development Program
Vert.	Vertical
WWM	Welded wire mesh

TABLE OF CONTENTS

Chapter	Contents	Page Number
1	Introduction to Disaster Prone Areas.....	1
2	Building Systems.....	5
3	Damage Types & Reasons	9
4	Vulnerability Identification.....	17
5	Basic Rules of Disaster Resistant Design.....	19
6	Basic Rules of Good Quality Construction.....	29
7	Disaster Resisting Features	40
8	Disaster Resisting Features - Regional Variations.....	62
9	Material Quantities for Disaster Resisting Features.....	67
10	Don'ts - New Construction.....	71
11	Restoration Procedures.....	75
12	Retrofitting Measures.....	82
13	Material Quantities for Retrofitting Measures.....	96
14	Don'ts - Restoration & Retrofitting.....	100
15	Tools and Equipment for Retrofitting.....	102
16	Basic Rules of Good Quality Non-Engineered RC Construction	104
	Appendix.....	109

Introduction to Disaster Prone Areas



In India different types of natural disasters like earthquake, cyclone and flood bring death and destruction in many places every year. To reduce the impact of disasters, people must know about the risk of different disasters and destruction they can bring, and building artisans should learn the techniques.

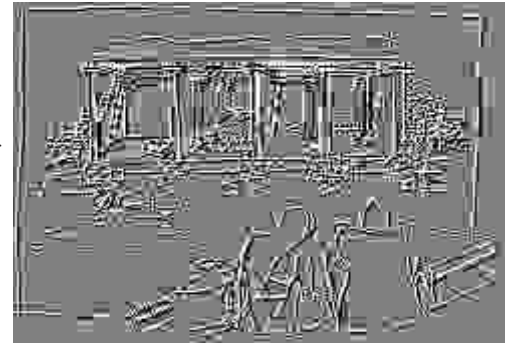

This manual is aimed at helping the building artisans improve their skills and learn about the disaster-resistant building technologies that they can use in their region. It can also be used by site supervisors, engineers and house owners to learn the practical aspects of such technologies.

This manual covers the most commonly used masonry walls including brick, concrete blocks and stone, and the most commonly used roofs including pitched roofs with roofing materials consisting of clay tiles and AC & CGI sheeting, and flat roof consisting of mud timber roof and RC slab.

Earthquake Risk

The map of India printed here shows the types of earthquake that can possibly occur and the risks involved. The person can locate his area on the map and become aware of the possible risk of future earthquake.

There are four different zones: Numbered II, III, IV & V. Zone II has the lowest risk and Zone V has the highest risk.

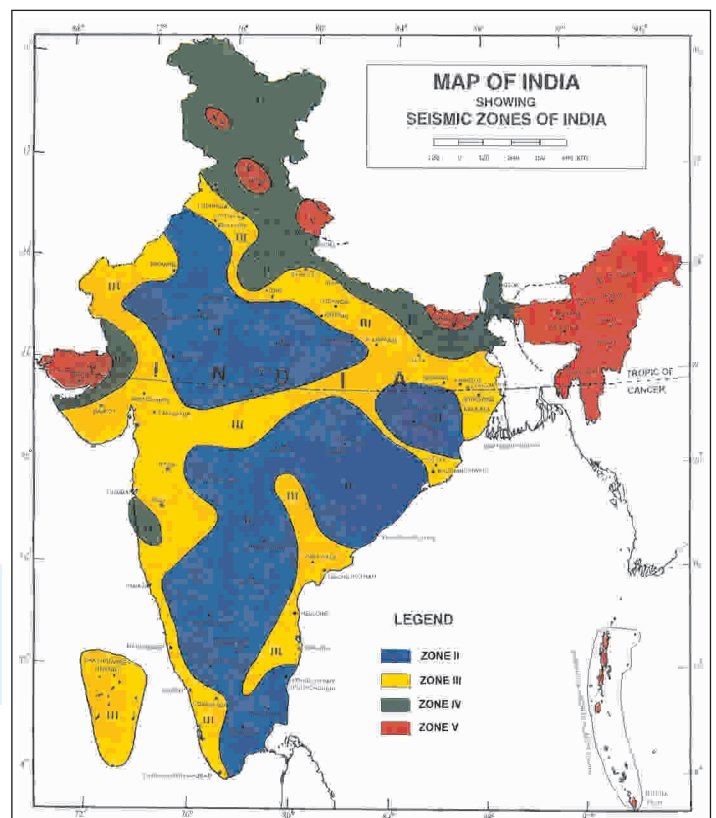



Expected Damage In Future Earthquake to Different Category Buildings*

Zone II:

Kachcha Buildings: About 50% will have fine cracks and about 5% moderate cracks.
 Semi Pucca Buildings: About 25% will have fine cracks.
 Pucca Buildings: No damage.



Moderate and fine cracks



Large cracks

Zone III :

Kachcha Buildings: About 75% will have large cracks and 5% will have collapsed portions.
 Semi Pucca Buildings : About 75% will have large cracks.
 Pucca Buildings: About 75% will have small cracks, and 5% will have large cracks.



Collapsed portions

Zone IV :

Kachcha Buildings: About 75% will have collapsed portions.
 Semi Pucca Buildings: About 75% will have large cracks, about 5% will have collapsed portions.
 Pucca Buildings: About 75% will have small cracks, and about 5% will have large cracks.



Total collapse

Zone V :

Kachcha Buildings: About 75% will collapse fully.
 Semi Pucca Buildings: About 50% will have collapsed portions and about 5% may collapse fully.
 Pucca Buildings: About 50% will have large cracks, and about 5% will have collapsed portions.

* Building Category

Kachcha Structures: Having walls made of mud, unburned bricks or soft stone.

Semi Pucca Structures: Having walls made of bricks, good quality stone, concrete blocks.

Pucca Structures: Walls made with cement mortar, timber and reinforced concrete.

1

Cyclone Risk

The map on this page shows areas known to experience high winds and cyclones. The person constructing a building in such area must take in to consideration the damage that can occur.

There are four zones based on expected maximum wind speeds in the area. Zone I has the lowest risk and Zone IV has the highest.

Expected Damage In Future Cyclone Zone I:

Low Damage Risk
Wind Speed up to 33m/s
Well-built Semi-Pucca Buildings:
Very little damage.
Loose corrugated galvanized iron (CGI) & fibre cement sheets and clay tiles fly off.

Zone II:

Moderate Damage Risk
Wind Speed 39 to 44m/s
Kachcha and Semi-Pucca Buildings:
Moderate damage.
Loose roofing clay tiles fly off; some roof sheets fixed to purlins also fly off.

Zone III:

High Damage Risk
Wind Speed 47m/s
Kachcha and Semi Pucca Buildings:
Heavy damage
Boundary Walls: Overturn
Industrial Buildings: Walls fail, whole roofs may fly off.

Zone IV:

Very High Damage Risk
Wind Speed 50 to 55 m/s
Similar to Zone III but the damage is more widespread as in a severe cyclone.

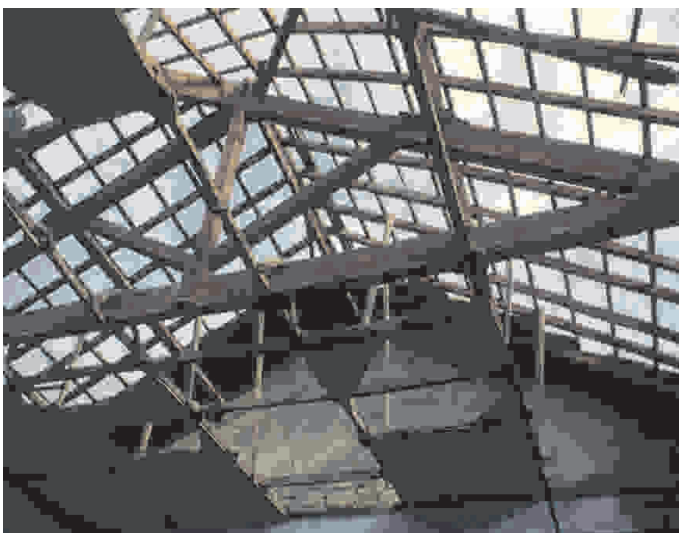
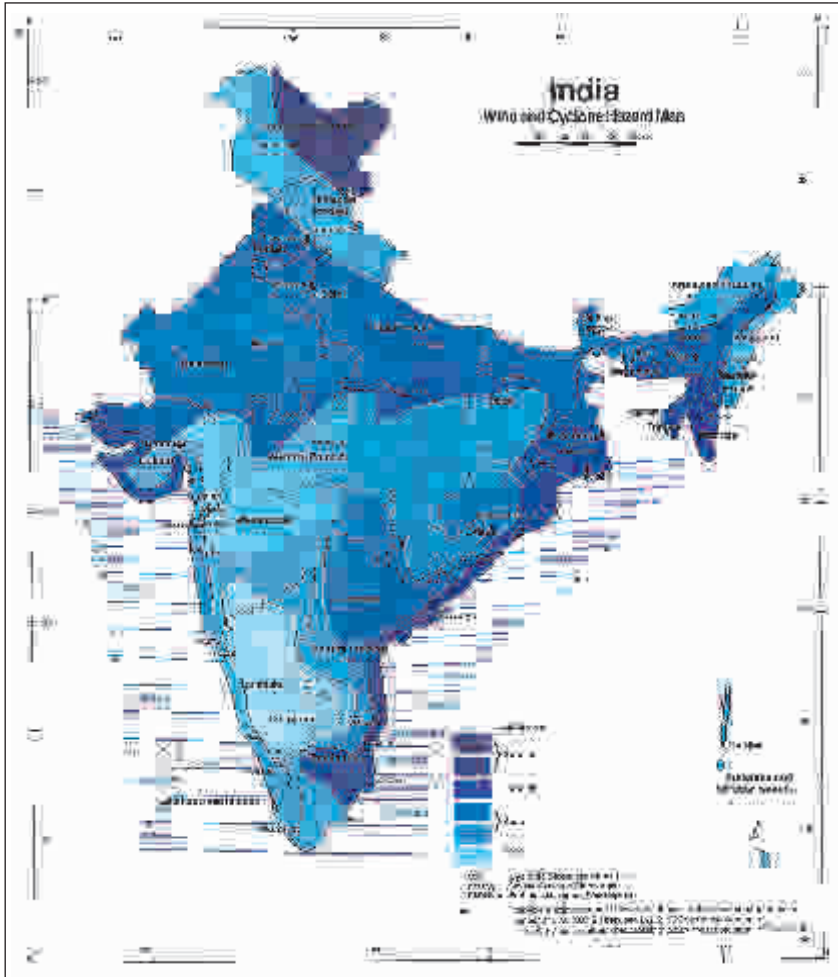

Blown off tiles due to high winds



Wall collapse due to tidal surge

1

Flood Risk

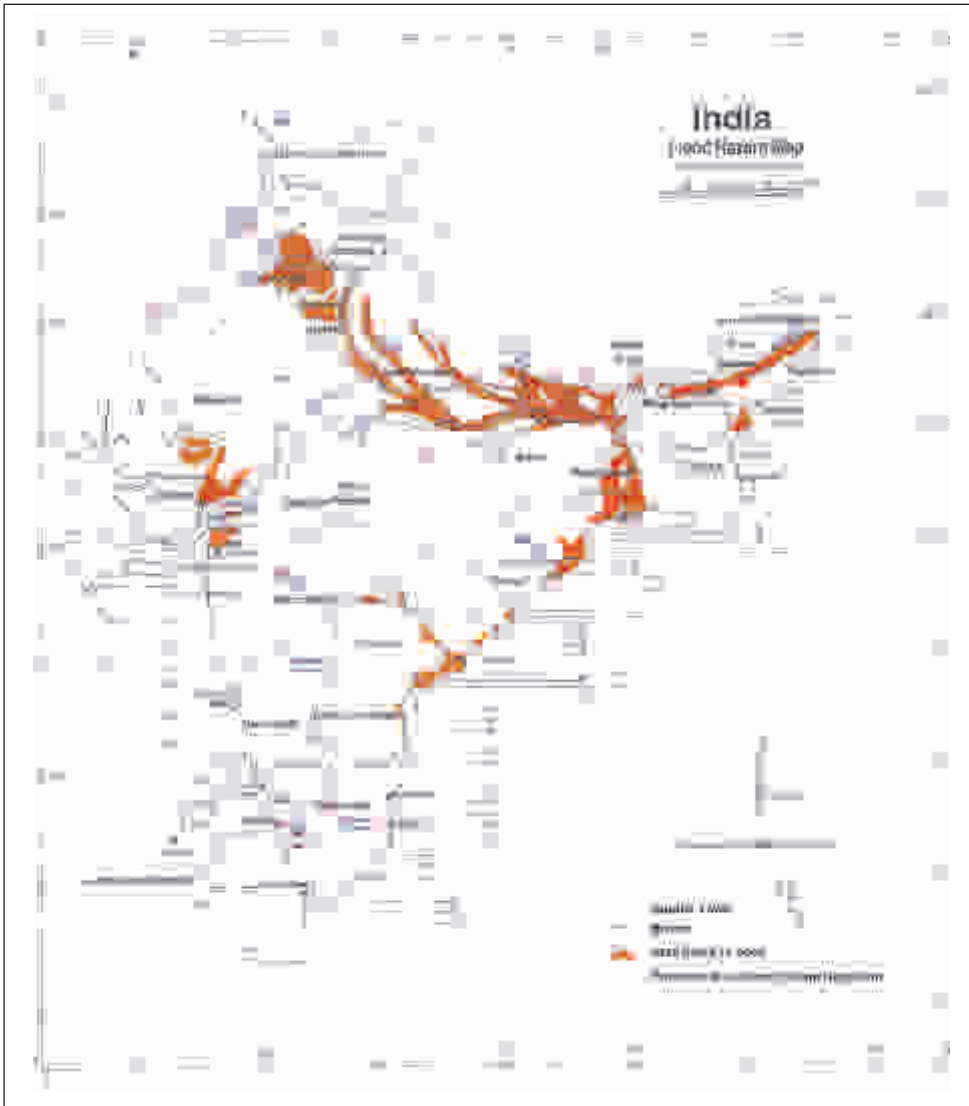

This map shows the areas that are known to experience major floods. Those constructing buildings in such an area must take into account the danger of flooding from rivers. In addition there could be a problem of local flooding due to heavy rains. The map also shows the tidal surge that can be expected.

Expected Damage In Future Flood

Flooding and fast moving water can cause structural damage due to water inundation and settlement of foundation due to scouring.



Water Inundation



Damage due to foundation settlement

Most Common Non-Engineered Building Systems in India

Majority of buildings in rural and semi-urban parts of the country are built by people with the help of local building artisan's with no help from engineers. These may be Kutchha or Pucca. These buildings generally have no more than two storeys. Two main pucca building systems are shown below.

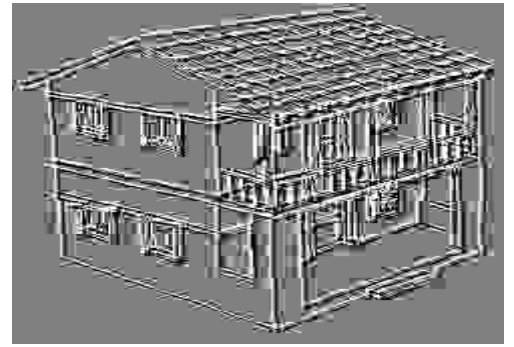

This is used for majority of houses and infrastructure buildings in villages, towns and cities. The walls carry all the loads and also resist forces of earthquake, cyclone and flood. It uses materials that are most easily available locally.

1. Load Bearing Masonry System



2. Reinforced Concrete Frame



This is used in towns and cities usually for multi-storey buildings. The RC frame carries all the loads and also resists forces of earth-quake, cyclone and flood. The cladding walls provide the security to the occupants from rain, cold, heat, and thieves.

This system is used based on engineering design but, some buildings are constructed without the help of an engineer.

Recent Transformation in Building Systems

In past few decades with increasing prosperity, improved availability of longer lasting materials, and timber becoming very expensive, the materials used have changed significantly and continue to change. As a result many building systems have become economically unviable.

This manual focuses only on those non-engineered building systems that are most popular and are most likely to remain in use across the disaster prone areas of the country.

1. Load Bearing Masonry System

A. With Pitched Roof

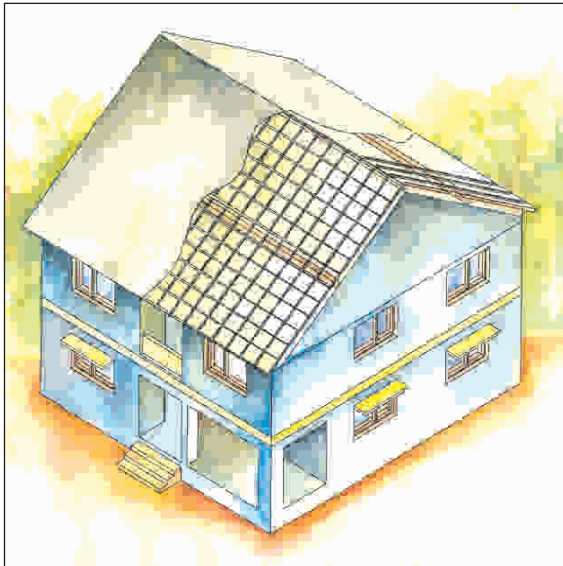

Materials for Walls

Walling: Brick, Concrete Block and Stone
 Mortar: Mud mortar from local clayey soil, Cement Sand mortar with proportions ranging from 1:6 to 1:12 often using sand from local streams containing high proportion of silt.

Materials for Roof

Roofing: Clay tiles, slate, CGI and AC Sheets
 Understructure: Sized and Round timber with different arrangement of main elements as shown below.



Large Purlins from Gable to Gable and over Principal Rafter



Rafters from Ridge to Eave Walls and over Intermediate Beams



Large Purlins from Truss to Truss

B. With Reinforced Concrete Slab



Materials for Walls

Walling: Brick, Concrete Block and Stone
 Mortar: Cement Sand mortar with proportions ranging from 1:6 to 1:12 often using sand from local streams containing high proportion of silt.



Materials for Roof

Flat Roof: Reinforced Concrete slab with cement, sand, aggregate concrete proportions ranging from 1:2:4 to 1:3:6 often mixed with silty sand and rounded aggregates from river.

C. Flat Mud Roofing on Timber Deck Supported on Timber Columns or RR Masonry Walls



Materials for Walls

Walling: Random Rubble Masonry
 Mortar: Mud mortar using local clayey soil.

Materials for Roof

Flat Roof: 200mm to 250mm (8" to 10") of impervious layer of clayey mud placed on heavy modular timber deck supported either on timber columns or directly on random rubble masonry

2

NEW TRENDS

In disaster prone high risk areas like Kashmir people are replacing mud roof with CGI sheeting. In Uttarakhand the slate roof is changing to RC slab or to CGI. In Kutchh people are changing thatch to clay tiles. In different parts of Arunachal Pradesh bamboo and timber roofs are changing to CGI. In all these areas those with more resources are replacing mud mortar by cement mortar.

1. Load Bearing Masonry System

A. With Pitched Roof



Clay tile Roof over Brick Walls

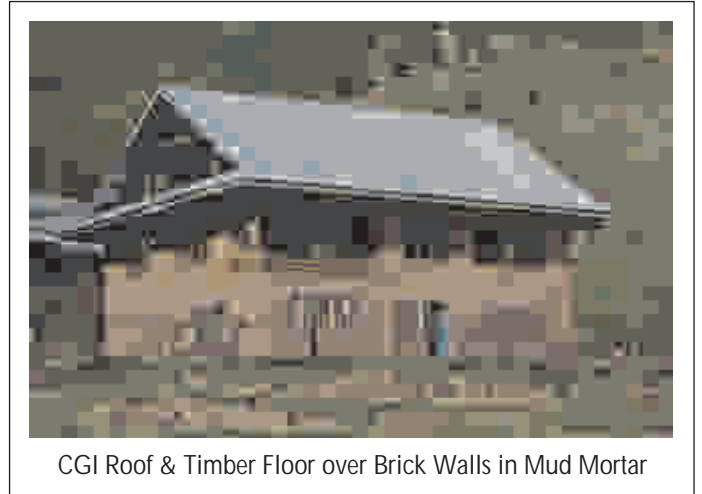

CGI Roof & Timber Floor over Brick Walls in Mud Mortar



Clay tile Roof over Concrete Block Walls in Cement Mortar

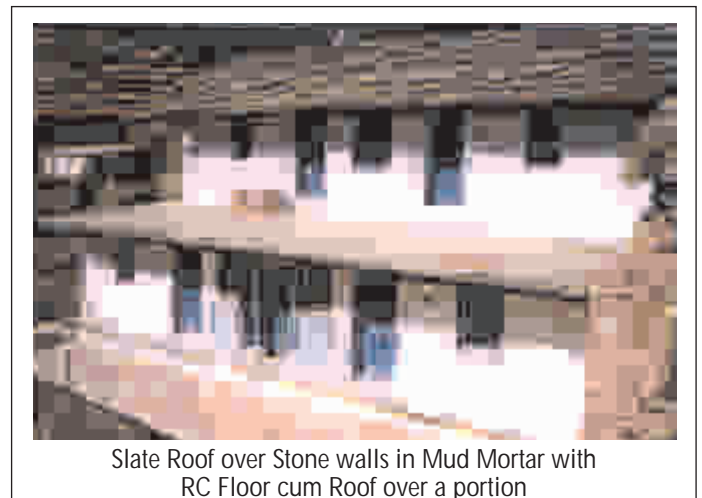

Slate Roof over Stone walls in Mud Mortar with RC Floor cum Roof over a portion



Tiled Roof Over Stone Walls in Cement Mortar



Slate Roof & Timber Floor Over Stone Walls in Mud Mortar

B. With Flat Concrete Slab Roof

In recent times RC slab roof has become popular, even though climatically it is not the best, it is a sign of modernity and requires maintenance less frequently. In such buildings mortar consists of cement mortar.



RC Slab Roof over Brick walls in Cement Mortar



RC Slab Roof over Stone Walls in Cement Mortar

C. Flat Mud Roofing on Timber Deck Supported on Timber Columns or on Masonry Walls

Mud roof with timber understructure is still found in many areas of country that receive less rainfall. It is popular as it is climatically appropriate and requires frequent but easy maintenance. Walls in such buildings are generally built with stone in mud mortar. With timber becoming very expensive and also scarce, in some areas it is being replaced by RC slab or CGI sheeting.



3

Damage: Types & Reasons

Damage Due to Natural Hazards

Earthquake, Cyclone and Flood, each one exerts a variety of forces, directly and indirectly, on buildings. The important factors that cause damage to buildings are

- Types of weaknesses in the building.
- Direction, speed and duration with which the hazard strikes a building.
- Earthquake : Magnitude (Richter Scale), the depth of epicenter and buildings' distance from it.
- Cyclone : Wind speed, and accompanying rain.
- Flood : Depth and duration of flood, and speed of water.

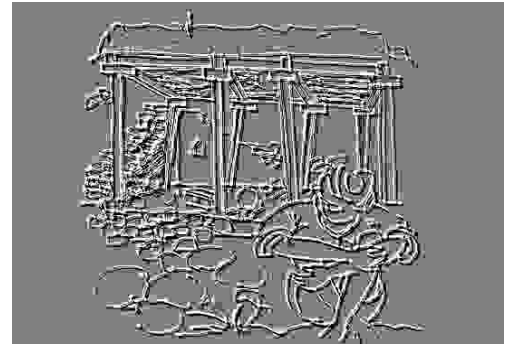

Earthquake Damage : Types & Causes

Earthquake makes the building and its parts bend, elongate, compress and twist. Various walls move in different directions. This causes tension in the walls and at the junction of various parts of the building. If the strength is not adequate then the damage occurs. Since mortar makes a significant contribution to the strength of masonry, the **weaker the mortar, more sever is the damage.**

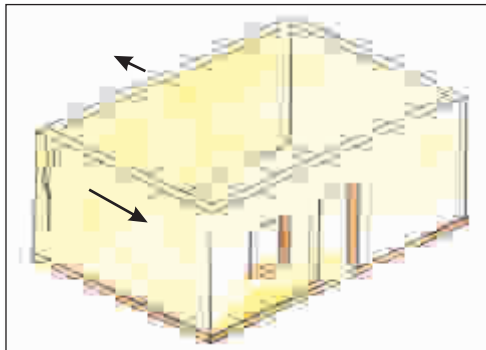

Vertical Crack at the Corner
Cause: Corner is weak and not able to take tension between two walls.

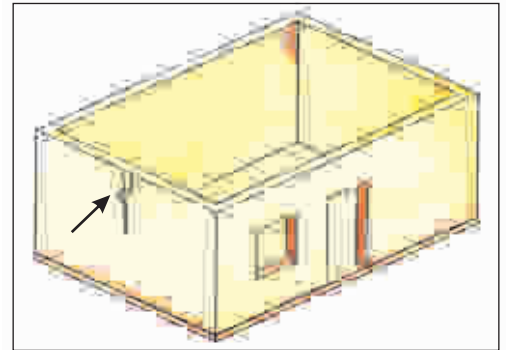

Vertical Crack away from corner
Cause: Wall is not able to withstand tension caused by its bending.

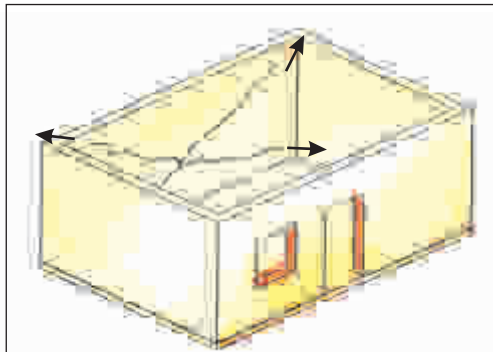

Diagonal Crack
Cause: The wall is not able to withstand tension resulting from elongation in diagonal direction.

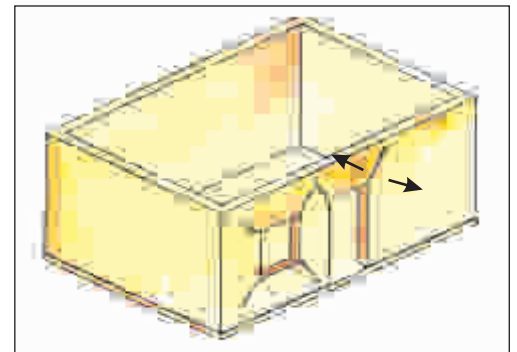

Diagonal Crack at the corner of the window and the door
Cause: Wall with openings is weak against tension in diagonal direction.

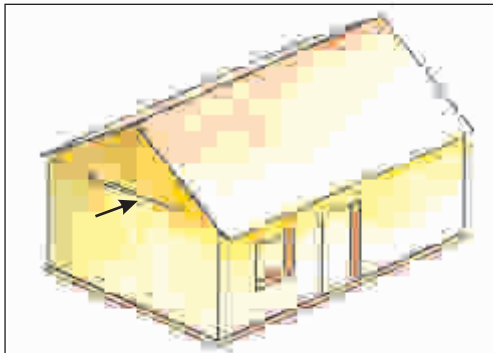

Horizontal Crack at the base of Gable Wall
Cause: Gable wall is unable to resist tension at its base caused by its back and forth shaking (bending).

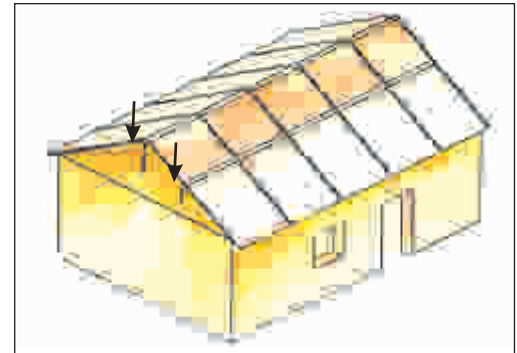

Crack under a beam
Cause: Wall is unable to resist splitting tension due to concentrated load from the beam during earthquake.

3

Earthquake damage: Types & Causes

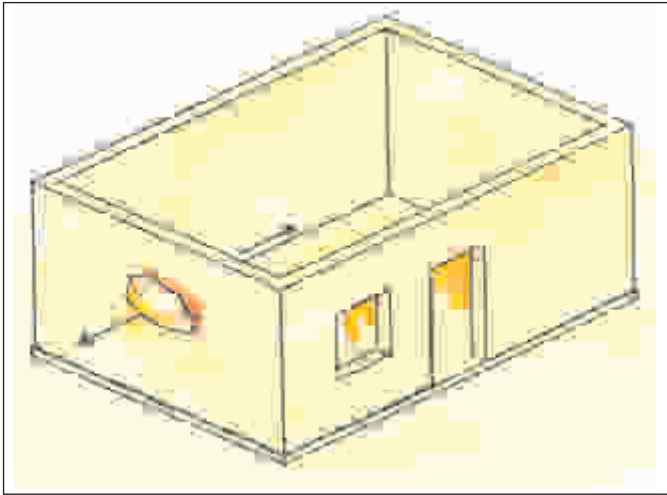

Wall bulged

Cause: In thick stone walls its outer and inner wythes (faces) are not interlocked adequately, and with shaking their separation begins, resulting in to bulging.

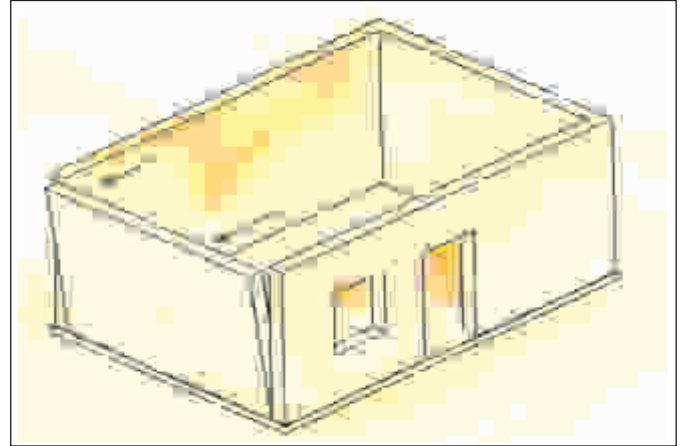

Wall going out of plumb

With both corners cracked wall loses its supports at ends. Any further shaking makes it tilt and go out of plumb.

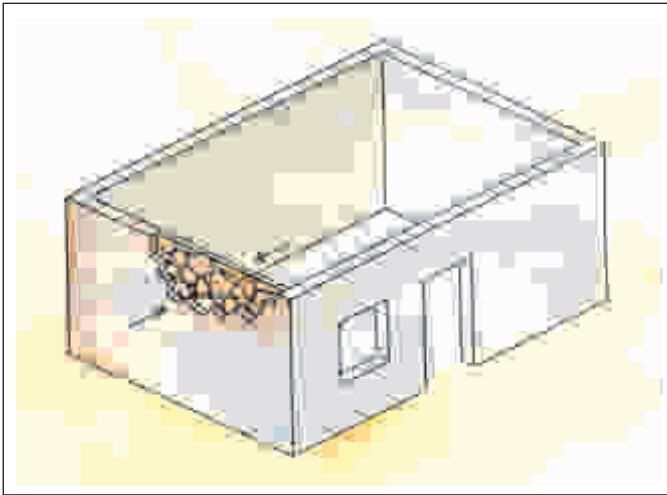

Wall with one face fallen and other intact (Delamination)

Cause: In thick stone walls its outer and inner wythes (faces) are not interlocked adequately, and with shaking one face separates and collapses.

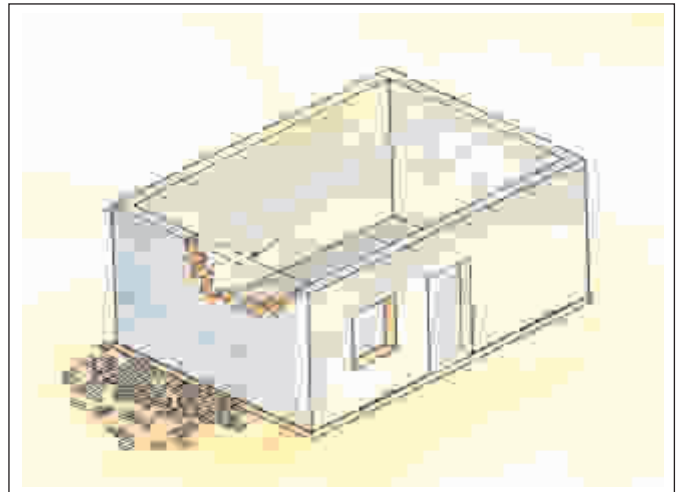

Wall with small portion at top having collapsed

Cause: Weak Wall without adequate roof anchoring is not able to withstand tension caused by back and forth bending.

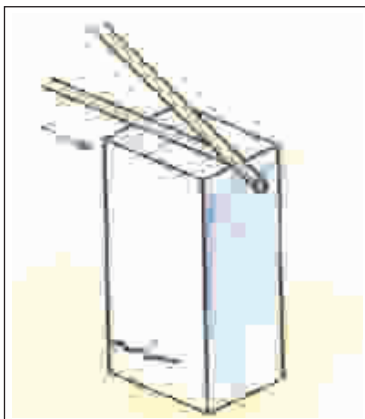

Cracked Masonry Column

Cause: The masonry column is not able to withstand tension resulting from its bending caused by the horizontal push from the roof supported on it.



Collapse of a part of the slab

Cause: Portion of support wall collapses, depriving support to a part of slab, resulting in the collapse of that part.

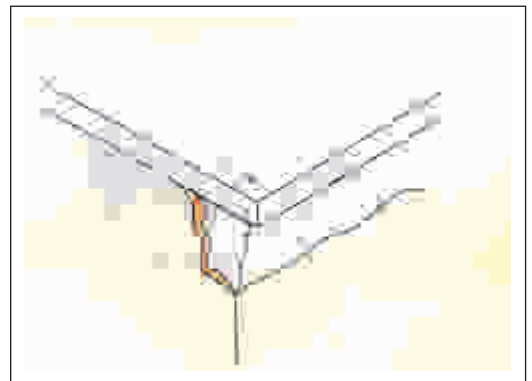

Slab sliding from its position

Cause: The weak joint between slab and wall is not able to withstand the horizontal force exerted by the slab on the wall.

3

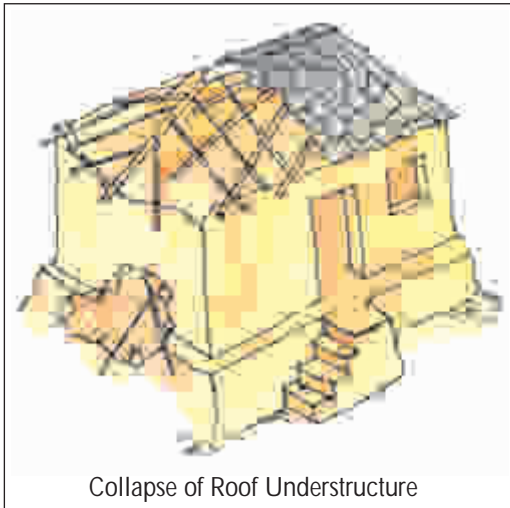

Collapse of Roof Understructure

Portion of support wall collapses resulting in the collapse of roof understructure.

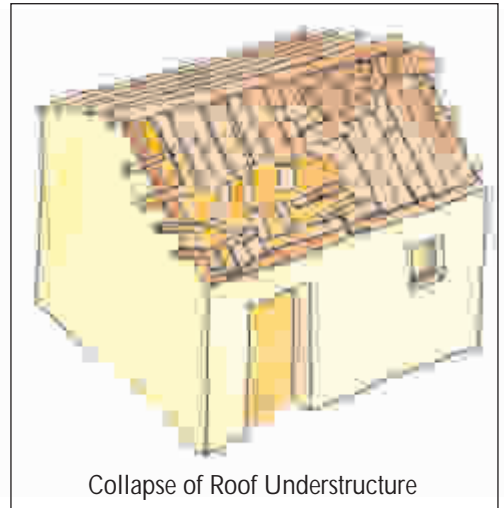

Collapse of Roof Understructure

Sudden shock causes breakage of rotten beam.

Photographs of Earthquake Damage to Walls

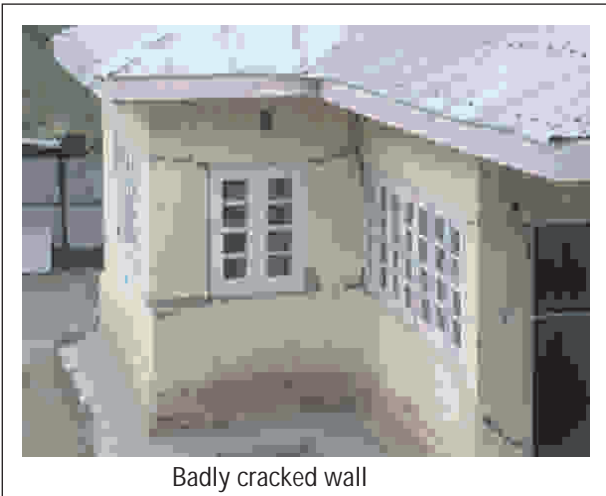

Badly cracked wall

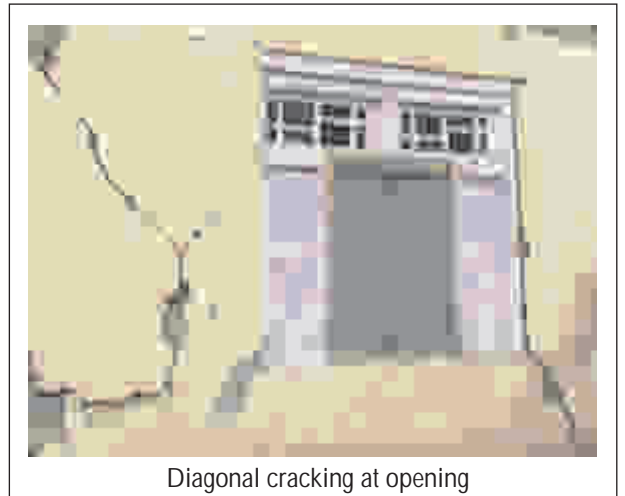

Diagonal cracking at opening

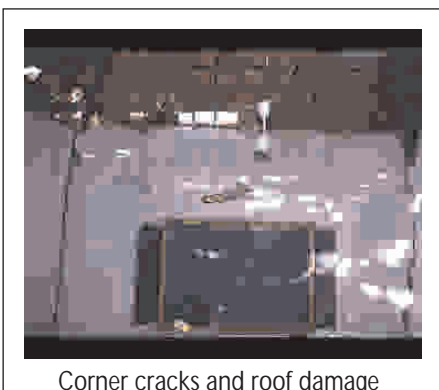

Corner cracks and roof damage

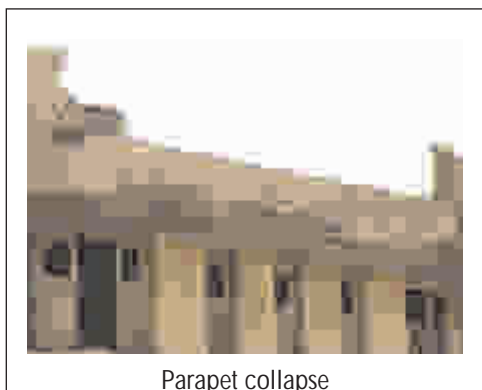

Parapet collapse

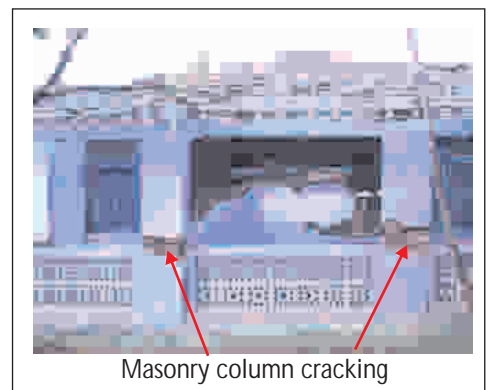

Masonry column cracking

Photographs of Earthquake Damage to Walls (cont.)

3



3

Photographs of Earthquake Damage to Roofs

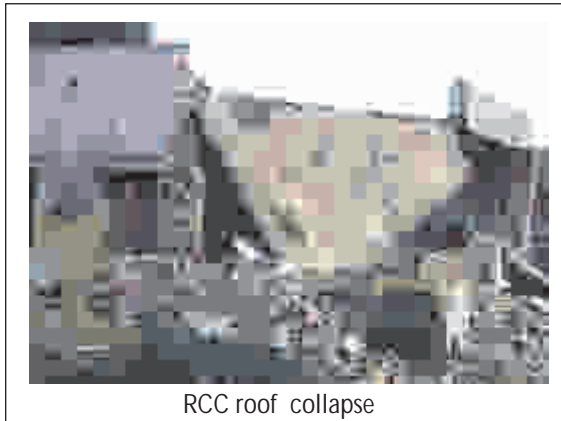

RCC roof collapse



Total collapse

Cyclone Damage: Types and Causes

The wind at very high speed creates pressure on some parts of the building and suction on the other. As a result the building and its parts bend and elongate. If the strength is not adequate then all this causes Cracks, parts of wall collapse, uplifting of roof, uplifting of projecting shades etc.

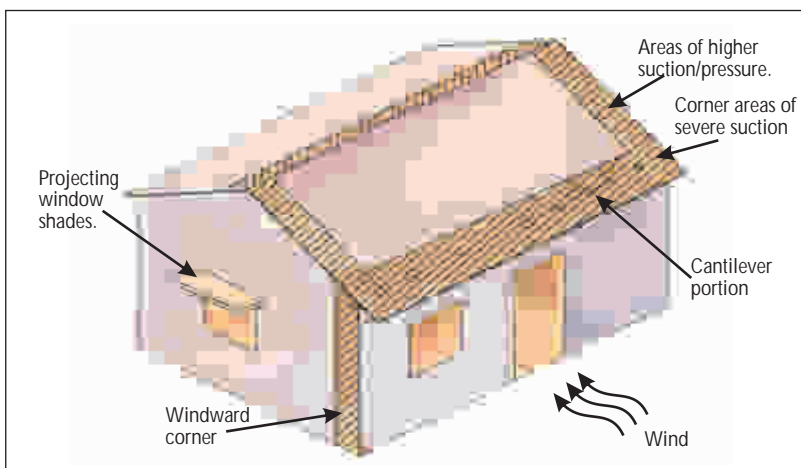

The wall facing wind is subjected to pressure. All other walls are subjected to suction. Different parts of roof are subjected to different amount of suction.

The damage to walls is very similar to that resulting in earthquake. Damage to roof is different and is as described below:

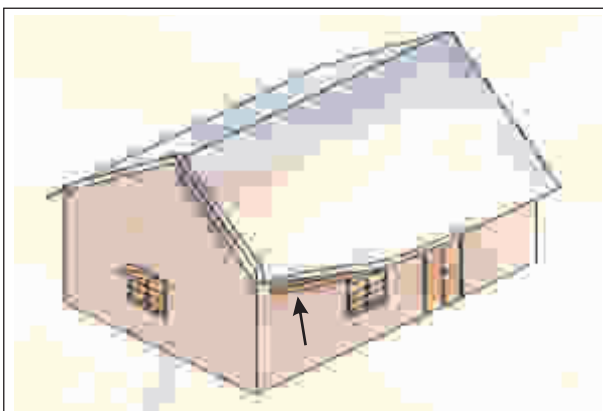

Eave level roof projection and Window Shades Lifted up

Cause: The weak anchoring of the outer edge of roof and of window shade are inadequate to resist the upward push by wind. If wind is stronger, then this can lead to blowing off of the whole roof.

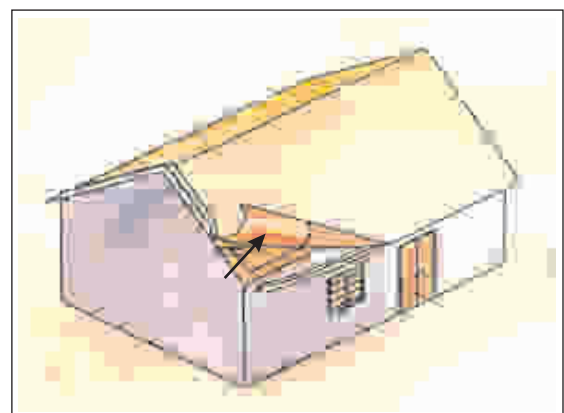

Roof Corner at Gable Wall Getting Lifted up

Cause: The weak anchoring of roof purlins and roofing on top of gable wall is inadequate to resist uplift caused by wind. If wind is stronger, then this can lead to blowing off of the whole roof.

Photographs of Cyclone Damage



Collapse of wall and damage to roof



Roof Tiles blown off

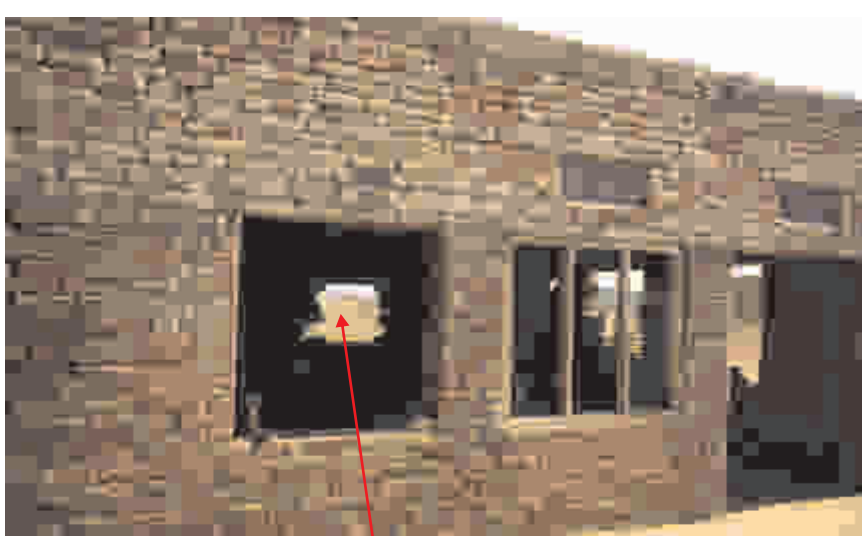

Damage to rear wall by suction



Damage by Cyclonic Surge



Wall & Roof damage by Cyclone

3

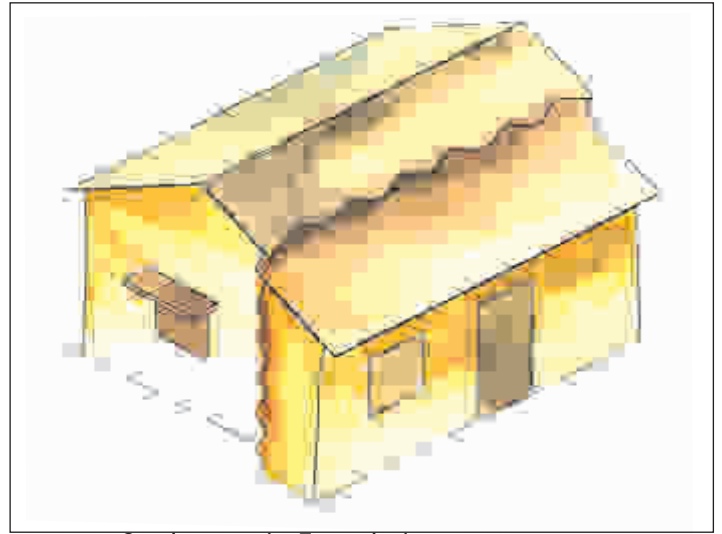
Flood / Rain Damage: Types and Causes**Settlement in Foundation**

Cause: Foundation is not able to support the wall load because of reduction in load bearing capacity of foundation soil due to rise in water table. This causes severe cracking in walls and in some cases, part of the building settles down.

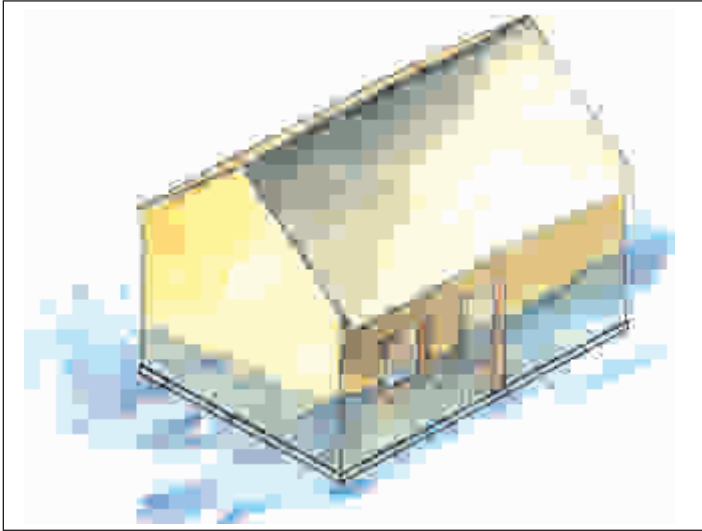
**Severe Cracking / Collapse of Wall**

Cause: Prolonged flooding and heavy rain cause the wetting of wall and mortar. This reduces the bearing capacity of mud mortar and clay wall, and so the wall is not able to support the roof. This results in severe cracking and even collapse.

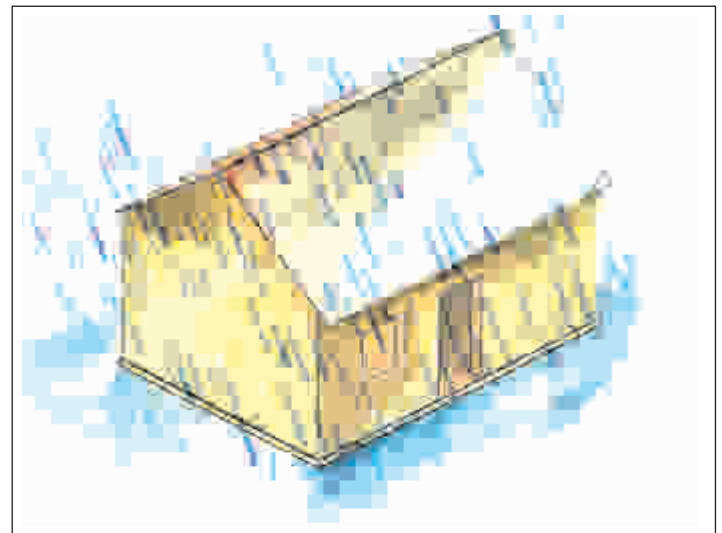
**Rain Damage**

Cause: Sustained rain for many hours causes erosion of mortar, or foundation resulting in cracking or even collapse of walls.

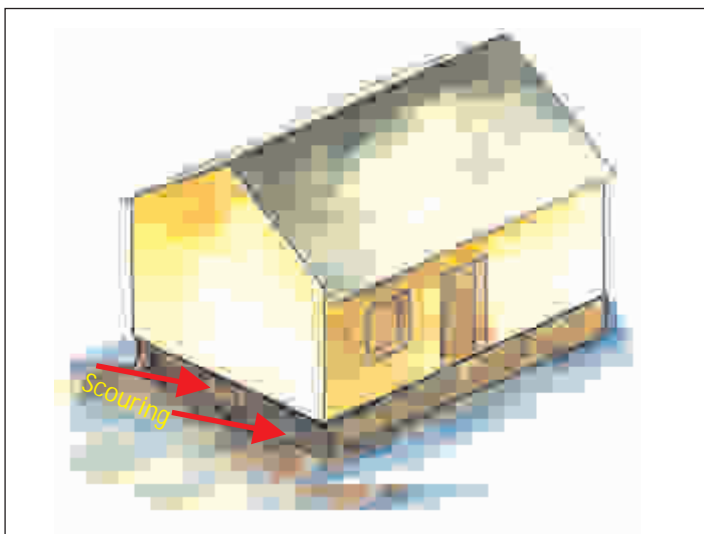
**Scouring of Wall Base**

Cause: Fast moving water erodes the foundation of the wall or erodes the wall mortar. This weakens the structure resulting into large holes or cracks or collapse of walls.

Photographs of Flood & Rain Damage

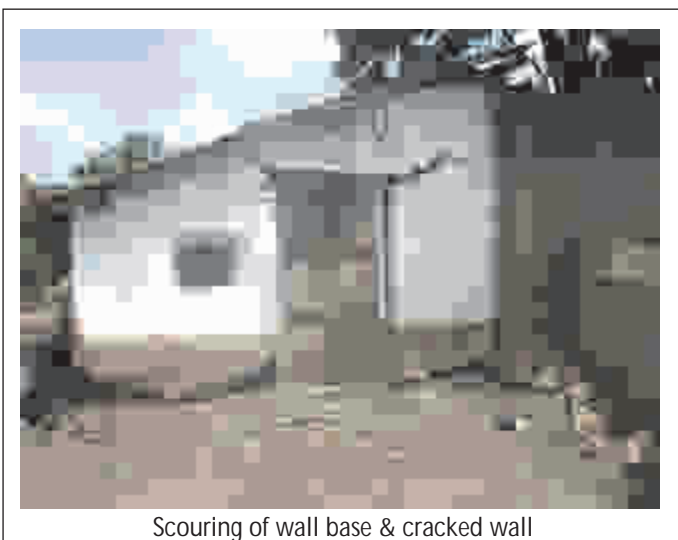
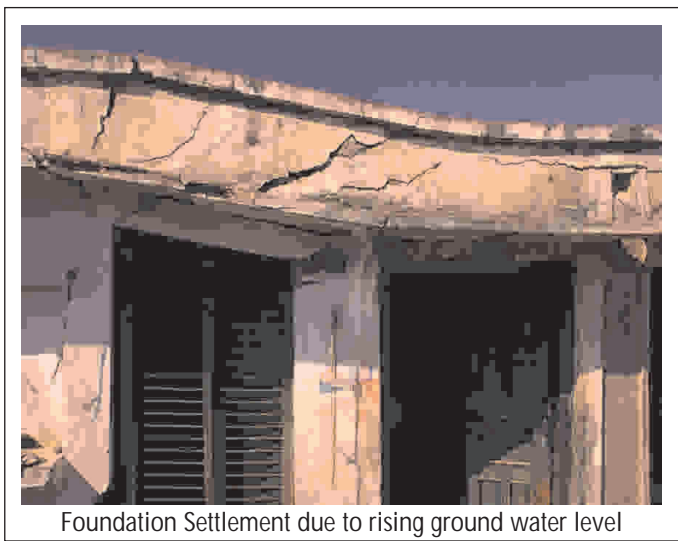

4

Vulnerability Identification

The weaknesses or vulnerabilities in a building against forces of earthquake, cyclone and flood must be identified in order to decide the remedial measures necessary to make the building safer.

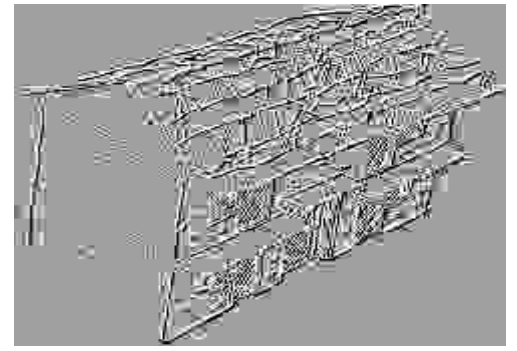

Vulnerability of Non-Engineered Buildings against Earthquake, Cyclone & Flood Hazards

In India masonry structures are built with similar construction practices using stone, bricks, concrete blocks, unbaked bricks or mud blocks for walls, with a variety of mortars including mud and cement mortars with widely differing proportions of different ingredients. The weaknesses in these walls are similar, but vary in degree of damagability because of varying strengths of the mortar as well as the quality of construction. The remedial measures to tackle these weaknesses are also similar except for the mud (clay) walls.

The bamboo and timber walled buildings are light weight and flexible.

In case of roofs the materials like clay tiles, CGI or AC sheets, slate, mud, thatch etc are used. Their support systems differ a great deal, thus requiring different remedial measures.



Mud wall and thatch roof house



Ekra style timber-bamboo walls



Timber walls

For mud walls there are no simple measures to make them disaster resistant.

For thatch roof there are no simple remedial measures to make them cyclone resistant.

Bamboo and timber walled buildings are earthquake resistant

Hence, in this manual the walls made of earth, bamboo or timber, and roof made of thatch are not included.

This manual covers load bearing masonry walls of stone, bricks, and concrete blocks, with mud and cement mortar, and pitched roofs with clay tiles, CGI/AC sheeting, and slate, and flat roof consisting of mud and RC slab.

Vulnerability of Non-Engineered Buildings against Earthquake, Cyclone & Flood Hazards



Based on the studies of damages to non-engineered structures due to various hazards the commonly observed vulnerability is shown in the diagram below. It is important to identify and apply the remedial measures for these.

VULNERABILITY AT A GLANCE

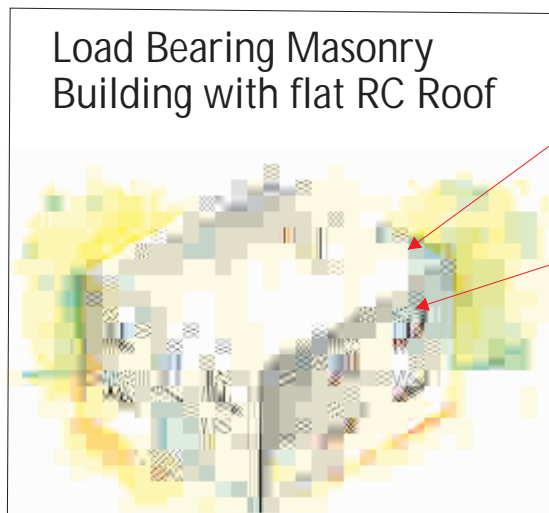
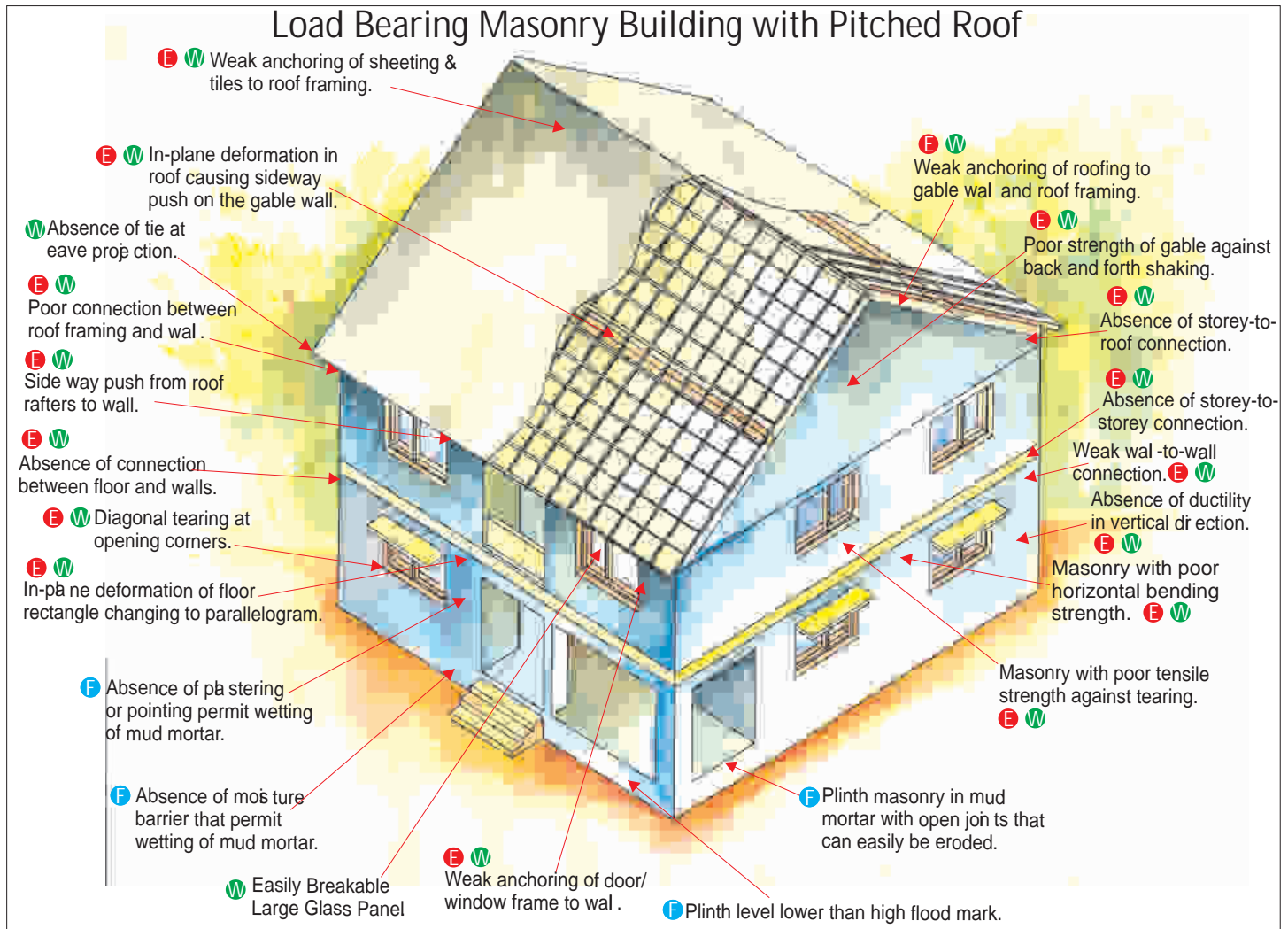

In a building with RC Slab roof the vulnerabilities below the roof level are same as those in a pitched roof building. But above that level they are different.

5

First Step in Disaster Safety

Adhering to the basic rules that provide guidance on the planning and designing of a disaster resistant building is the first step in safety against disaster. This is irrespective of what materials are used in construction.

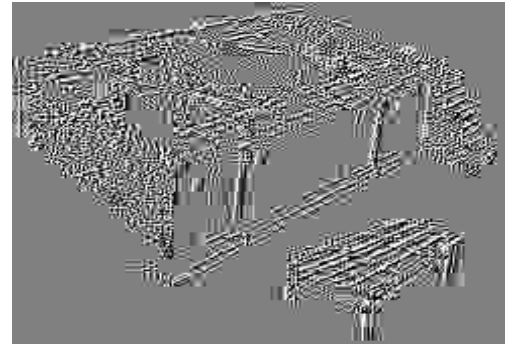

1. Examples for Better Understanding of Disaster Resistant Construction Principles

Bus moves on bumpy roads but does not fall apart because all its sides, top and bottom are connected together solidly.

A cardboard box open at the top with some weight in it, gets distorted if you lift it. But if its flaps at the top are closed, its shape does not change when lifted.

A house is like a bus or a cardboard box. If all its walls, roof and foundation are tied together well it will not fall apart or deform if shaken by an earthquake or a cyclone.

Basic Rules of Disaster Resistant Design

1. Examples for Better Understanding of Disaster Resistant Construction Principles (Cont.)

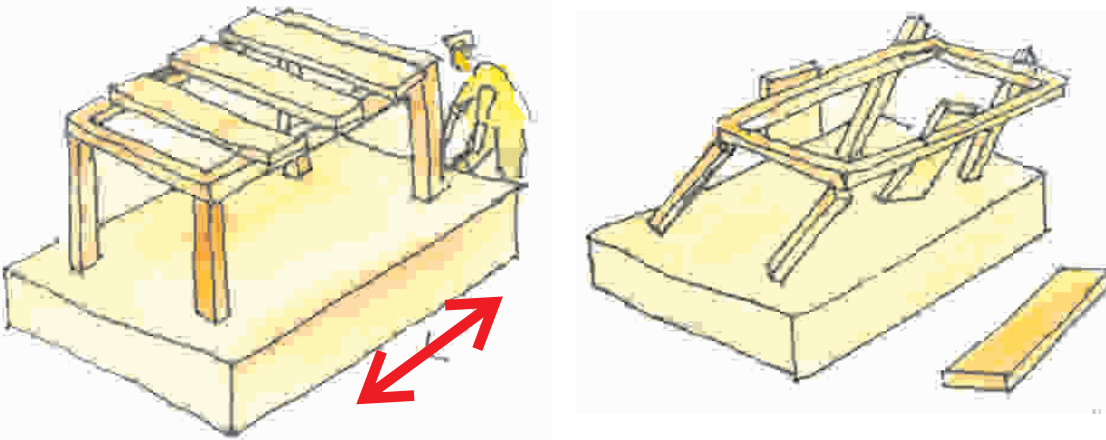

If a table, with heavy top that is poorly attached to its supports, is shaken violently, the supports can break off and the table can collapse. A building with heavy roof is like the table. If its roof is not attached well to its supports and supports are weak, then it can collapse in an earthquake.

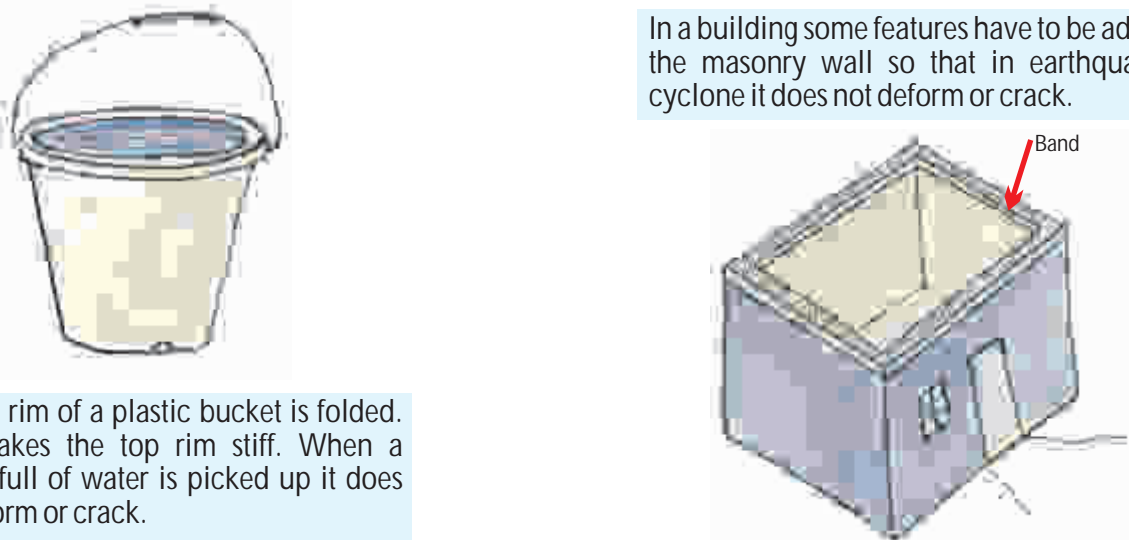

The top rim of a plastic bucket is folded. This makes the top rim stiff. When a bucket full of water is picked up it does not deform or crack.

In a building some features have to be added in the masonry wall so that in earthquake or cyclone it does not deform or crack.



In an earthquake or cyclone a tree does not collapse. It bends and returns to its original position because it is elastic and strong. Masonry walls bend and crack. Some features need to be added to make them ductile/elastic.

5

Rules described here apply to different hazards. But all the rules help in making the building stronger and lasting longer. With each rule a special symbol is assigned for its applicability to a particular hazard.

E Earthquake

W Wind

F Flood & Rain

2. Locating the Building

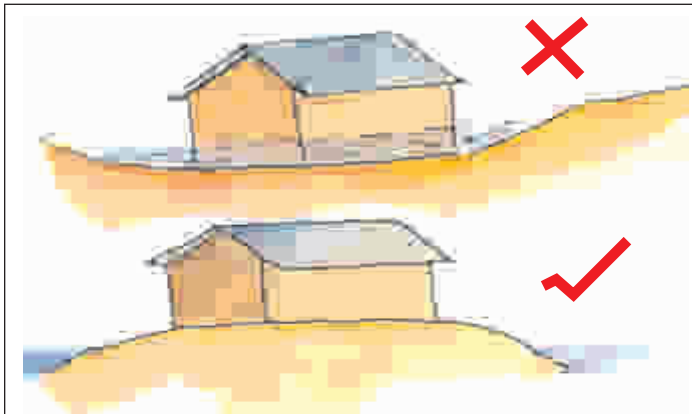

W F

Avoid all low lying areas for construction as it can be inundated with water in case of heavy rain.

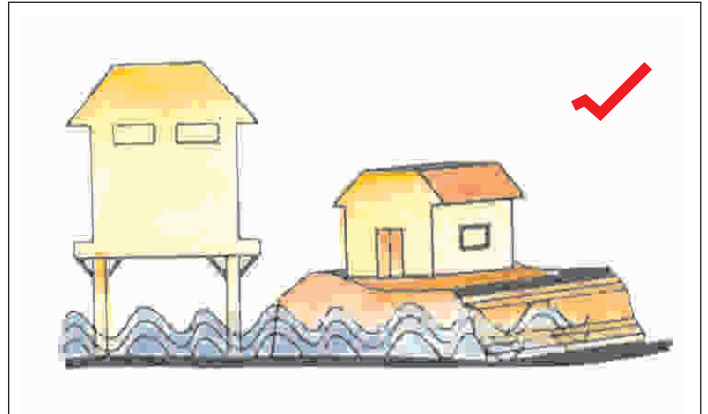

W F

If higher ground is not available then construct on artificially raised ground or on stilts.



W

Select site that is sheltered from cyclonic winds.

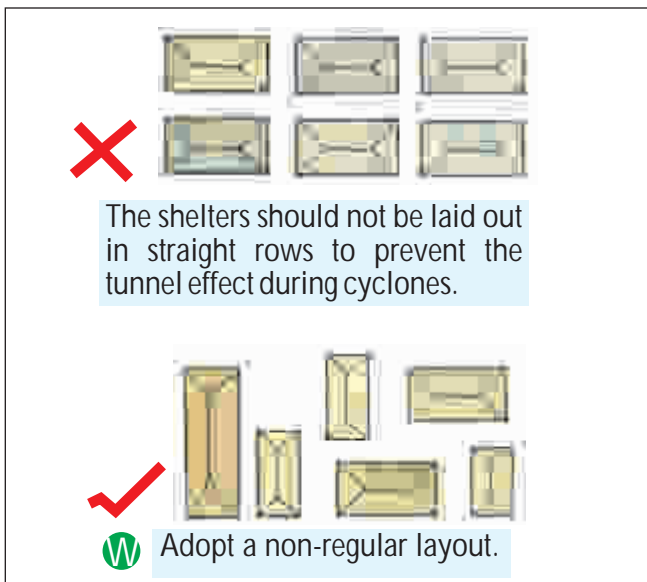
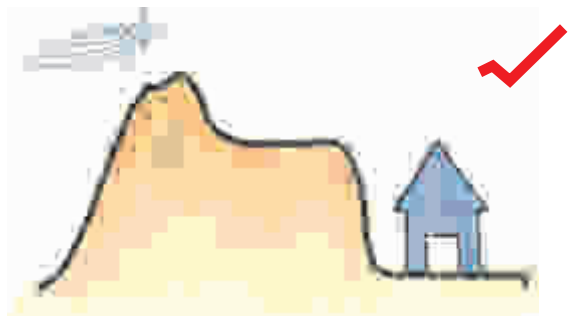

The shelters should not be laid out in straight rows to prevent the tunnel effect during cyclones.

W Adopt a non-regular layout.

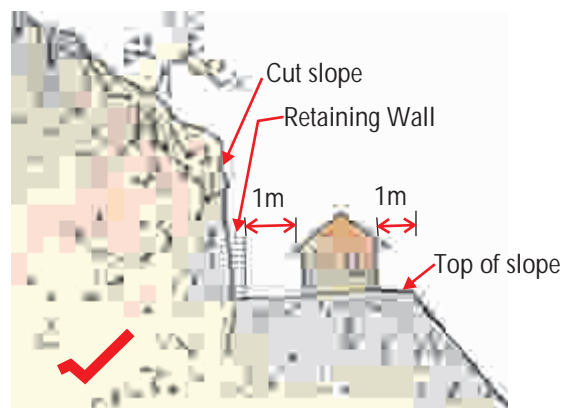

F E Construct building at least 1m away from top of slope and 1m away from the cut. Also construct retaining wall to support very steep cut slope.

3. Building Plan & Form

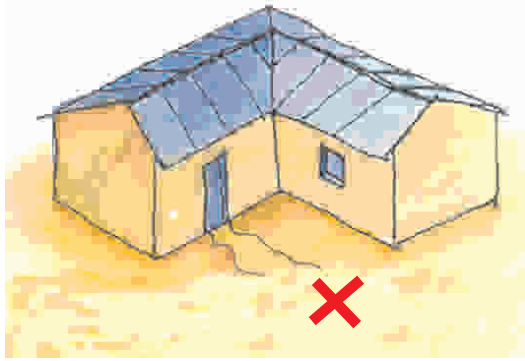

E **W**
 Building with symmetrical plan is safer than the one with asymmetrical plan.

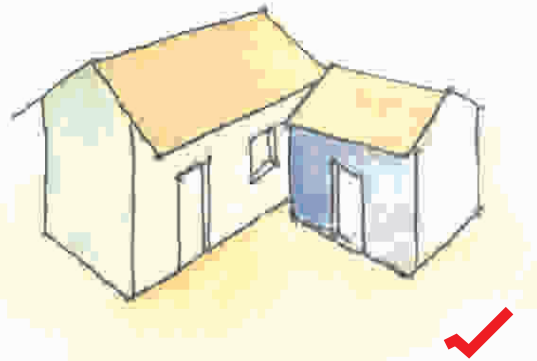

E **W**
 It is best to divide the building into a number of symmetrical units.

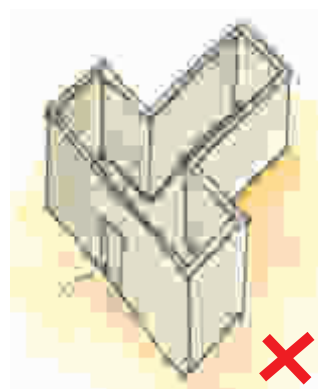
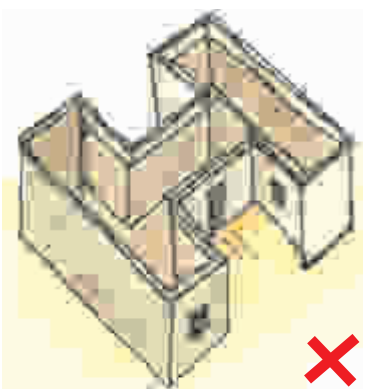
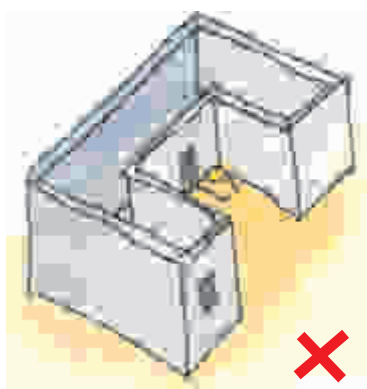

E Avoid making buildings with plans having 'C', 'H', 'T', or 'L' shapes in disaster prone areas.

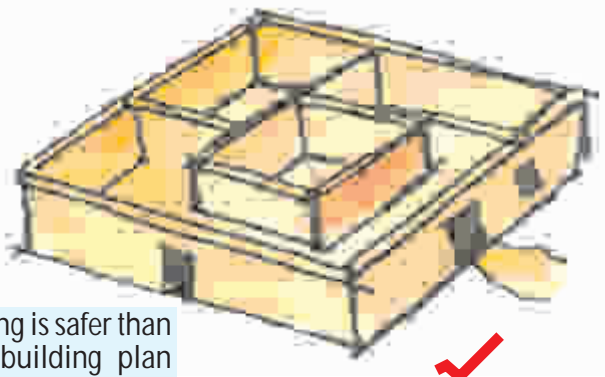
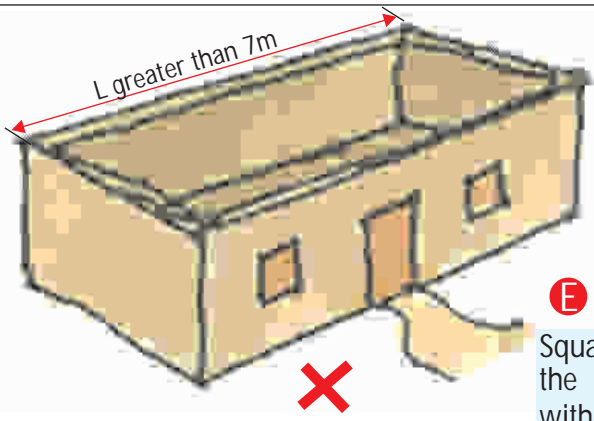

E **W**
 Square plan of a building is safer than the long rectangular building plan with walls longer than 7m (23').

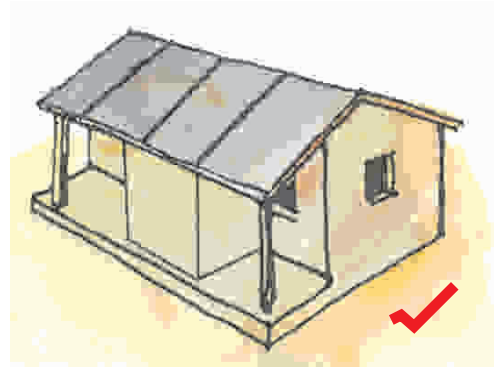

E **W**
 House with verandah in one corner can get damaged more easily than a house with verandah in the centre or with verandah symmetrically located in corners on both sides.

5

3. Building Plan & Form (Cont.)

Very long building can get damaged or even collapse easily than a shorter building. Avoid constructing a house with length more than 3 times its width "B". Otherwise divide the building in two separate units.

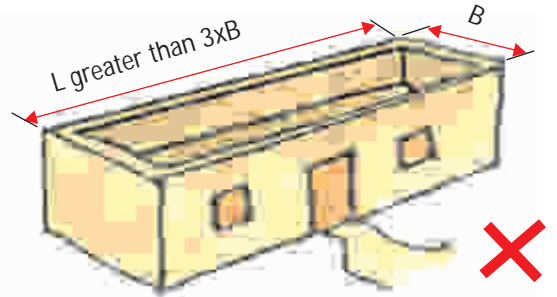
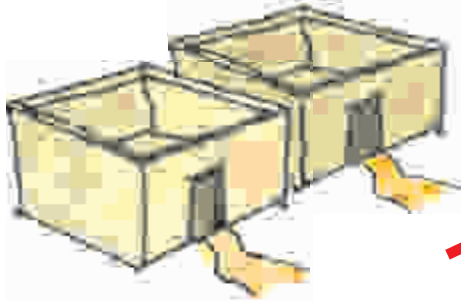

No Gable wall

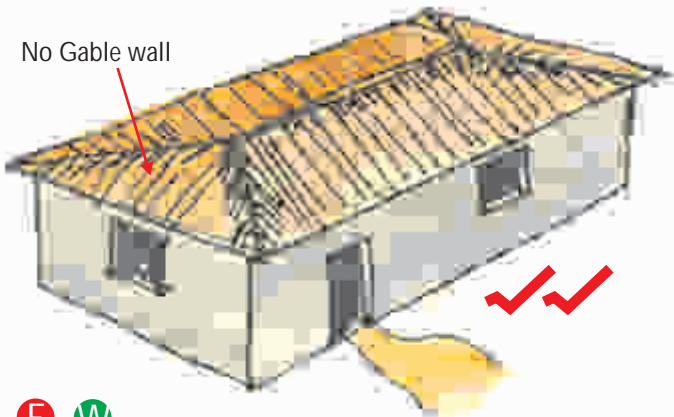

Building with four-sided sloping roof is stronger than the one with two-sided sloping roof.

Gable walls in two-sided sloping roof collapse easily.

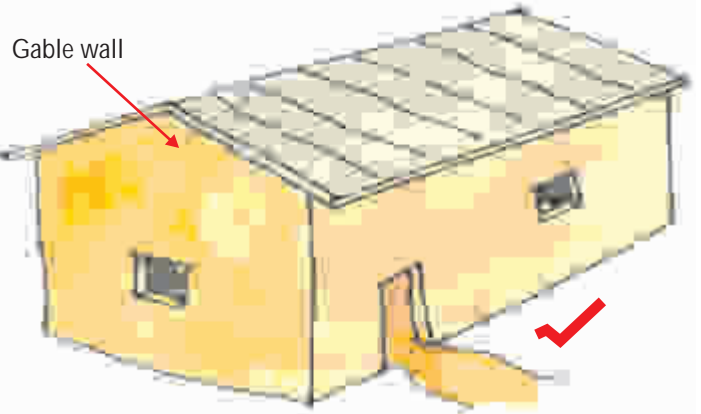

House should be ideally square or round. The pyramid shaped roof is ideally suited.



22° to 30°

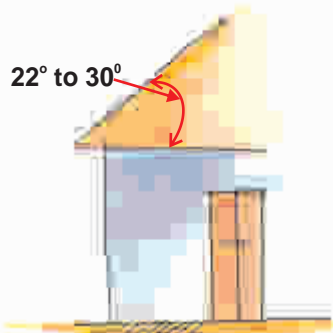

For pitched roof the roof slope should be between 22° to 30° for greater cyclone safety.



500 max

Roof overhang must be no more than 500mm (20") in rainy areas. In dry areas like Kutchh it can be as little as 150mm (6")

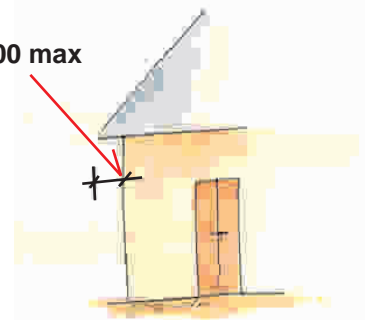

5

4. Walls - Length, Height, Thickness & Connection

Proper wall-to-wall joint

E W

Wall longer than 7m (23') can collapse easily. Make it stronger by constructing cross walls that are securely connected to the long wall.

Improper wall to wall joint

Proper wall to wall joint

E W

A partition wall built after the construction of outer walls can collapse easily.

Build partition wall simultaneously with other walls.

Masonry parapet wall can collapse easily. Build it with brick wall only 300mm (1') high followed with iron railing above for desired height.

E W

High parapet

Low parapet 300mm high

Iron railing

Wall that is tall but thin can easily collapse. Thicker wall does not collapse easily.

E W

Interior Load-bearing Wall 100mm Brick Thick

Interior Load-bearing Wall 230mm Brick Thick

E W

In a load bearing structures never use 100mm (4") brick wall. Such a wall is weak to resist bending and diagonal tension caused by earthquake and cyclone loads.

5

4. Walls - Length, Height, Thickness & Connection (Cont.)

Load-wall taller than 230mm without any reinforcement

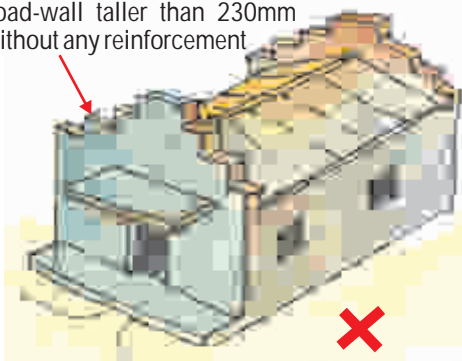

✗

Low load wall only 230mm high with 8mm Tor reinforcing bar

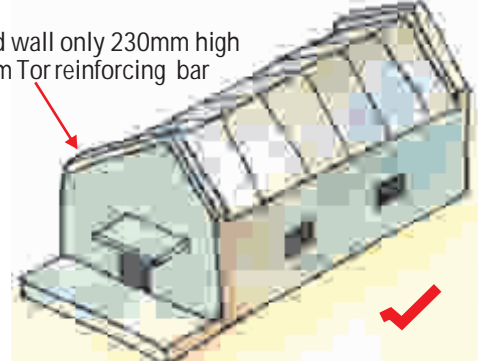

✓

E W

High load walls on sloping roof collapse easily like parapet wall. Construct load walls no higher than 230mm (9") and reinforce it with reinforcing rod inside for greater strength.

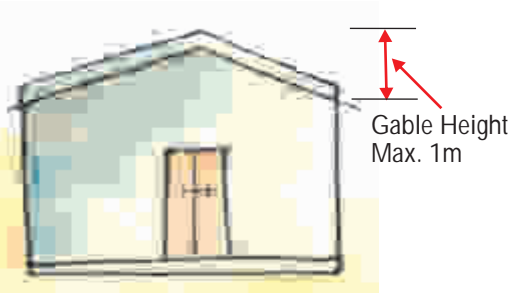

E W

Height of the gable walls shall not be more than 1000 mm (3'-4") above eave level.

Timber or CGI gable walls

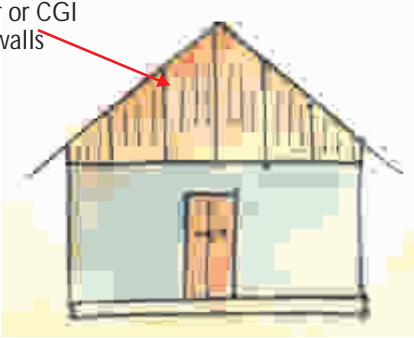

E W

If gable wall is taller than 1m then it is safer to build it with lighter material like CGI sheets or timber planks.



E W

To prevent cracks at the corners, strengthen them by constructing buttresses in the corners.

Wall Length

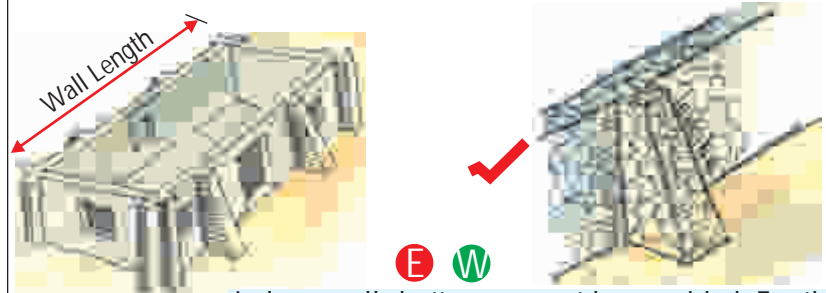

E W

In long walls buttresses must be provided. For their spacing and maximum wall length see Chapter 7

5. Walls - Openings

Too many openings in one wall

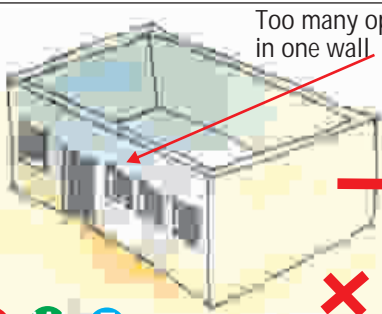

✗

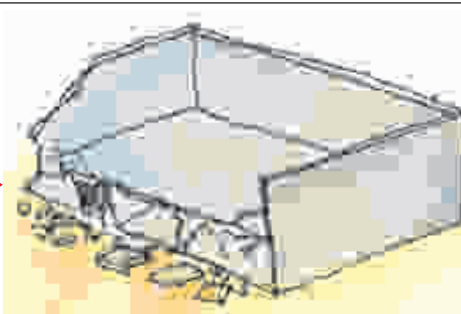

✓

E W F

Walls with too many doors and windows close to each other could collapse easily. Opening should be restricted to small sizes and few in numbers.

In smaller rooms provide no more than one opening in each wall.

5

5. Walls - Openings (cont.)

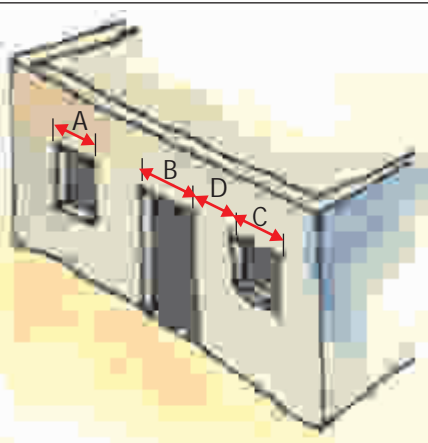

E W Gap "D" between two openings must not be too small.

The total length of all openings or "A+B+C" in a wall should not be too large .

For more information see Chapter 7

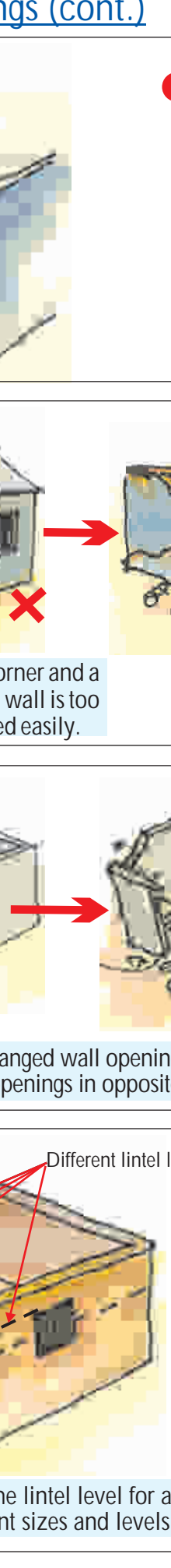

E W If the gap "E" between inside corner and a door or a window opening in a wall is too small, the wall can get damaged easily.

The gap "E" should be larger for more strength. For more information see Chapter 7.

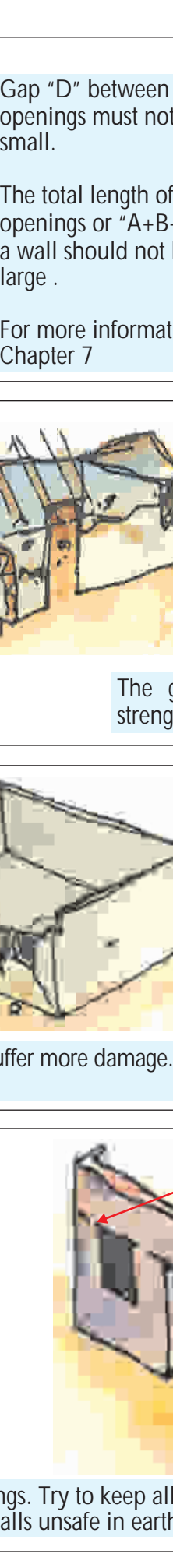

E W House with asymmetrically arranged wall openings can suffer more damage. For symmetry place identical openings in opposite walls.

When possible, place door in the center of the wall with openings placed symmetrically on both sides.

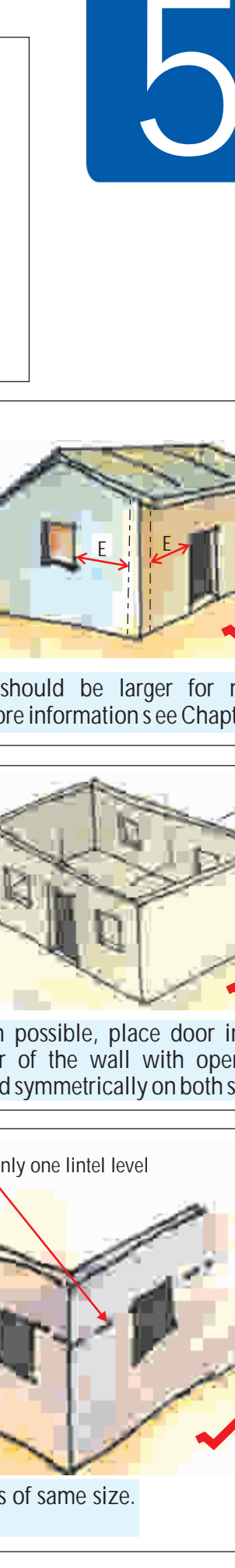

E W Maintain same lintel level for all openings. Try to keep all windows of same size. Many different sizes and levels make walls unsafe in earthquake.

5

6. Building Components

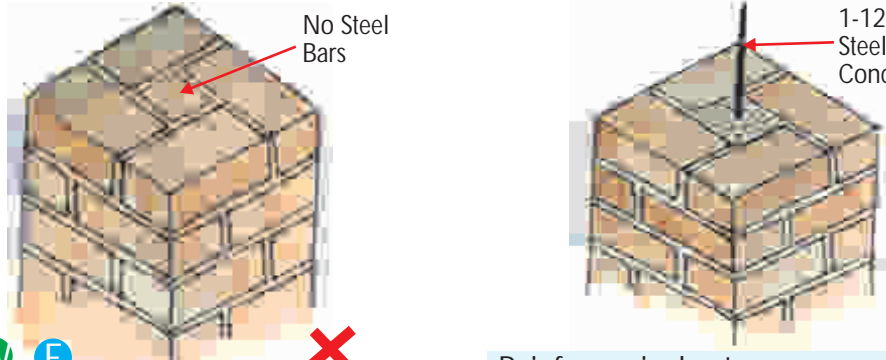

The diagram shows two masonry columns. The left column is made of brick and stone with no steel bars, labeled 'No Steel Bars' with a red arrow. The right column is made of brick and stone with a 1-12mm TOR steel bar fully encased in concrete and anchored at the top and bottom, labeled '1-12mm TOR Steel Bar in Concrete' with a red arrow. A red 'X' is next to the un-reinforced column, and a red checkmark is next to the reinforced column.

E W F **X** Do not make un-reinforced brick or stone masonry columns.

1-12mm TOR Steel Bar in Concrete **✓** Reinforce single story masonry column with 1-12mm TOR bar fully encased in concrete and anchored at top and bottom.

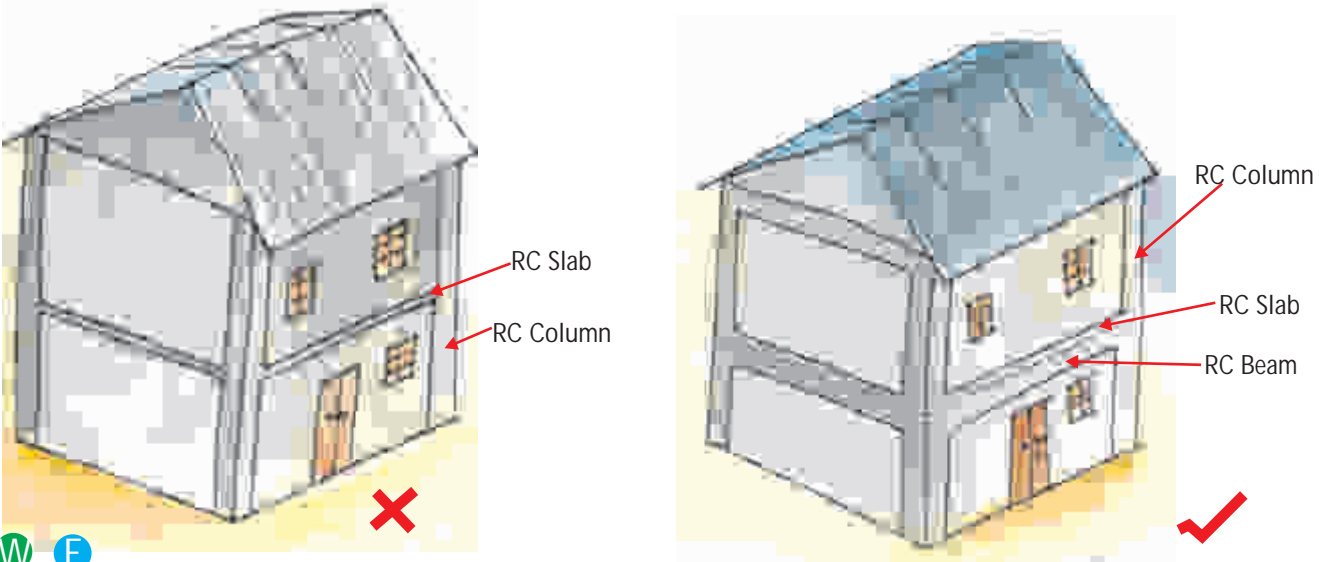

The diagram shows two two-story buildings. The left building has RC columns and an RC slab, but no beams, labeled 'RC Slab' and 'RC Column'. The right building has RC columns, an RC slab, and an RC beam, labeled 'RC Column', 'RC Slab', and 'RC Beam'. A red 'X' is next to the building without beams, and a red checkmark is next to the building with beams.

E W F **X** In absence of beams the RC columns break the wall to wall joints and hence, weaken the building making it unsafe.

RC Column **RC Slab** **RC Beam** **✓** Use RC columns in load bearing masonry structures only if RC beams are placed on them.

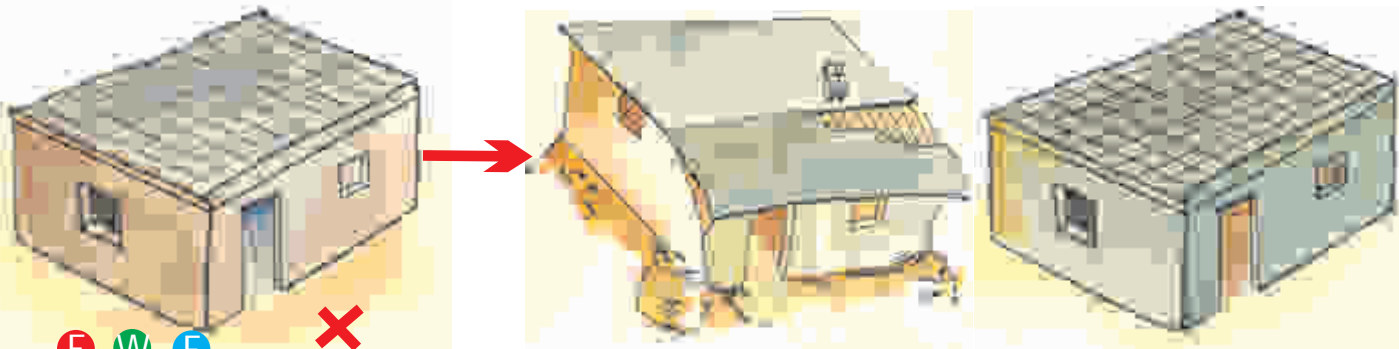

The diagram shows a sequence of three images. The first image shows a single-story building with a roof supported by two walls, labeled with a red 'X'. The second image shows the roof and walls of the building collapsing. The third image shows a single-story building with a roof supported by four walls, labeled with a red checkmark.

E W F **X** Never support RCC slab on two walls only. In case of one wall collapsing, the whole roof can collapse.

✓ Support RC slab on all four walls.

7. Roof & Chhajja

Rafters. Trusses

E W In a sloping roof with span greater than 6m use trusses instead of rafters.

No Wall plate Wall plate No Wall plate Wall plate

E W F **E W F**

Never place joists and trusses directly on wall. Place joists on RC Band to reduce concentrated loads, and to anchor them.

Never place rafters & trusses directly on wall. Place them on wall-plate to reduce concentrated loads, and to anchor them.

Height "h" of wall above the chhajja must be equal to length "L" of projection unless there is heavy roof resting on wall.

Support beams must extend into walls 1 1/2 times length of projection.

Column Support Column Support

E W For chhajja, roof and balcony projecting out less than 0.92m (36") follow above instructions.

For chhajja, roof and balcony projecting out more than 0.92m (36") provide column

6

Basic Rules of Good Quality Construction

Adhering to the principles of good construction is the second step in safety against disaster. Due to mistakes by mason the quality suffers. As a result efforts and money spent on special disaster safety measures may still not bring safety.

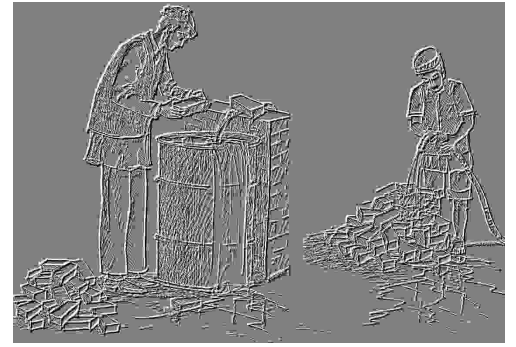

To ensure safety follow all the rules and do not make mistakes

A. Rules for Mortars

Mortar makes a major contribution in the strength of masonry. So all rules must be adhered to. Weak mortar makes weak masonry. Strong mortar makes strong masonry.

1. In construction use only one type of mortar for all the walls in a building.
2. Mud Mortar



If constructing in mud mortar, mud must be of good quality clayey soil.

It must be kept wet at least for three days and must be thoroughly mixed everyday before using it.



3. Cement Sand Mortar

- a. In making Cement Sand mortar follow all rules of Cement Application as given here.
- b. Quantity of water added to cement sand mixture must be just enough so that mortar can be spread without much difficulty

B. Rules for Cement Application

Cement increase the strength of the structure only if the application follows the rules. Never use mortar/concrete in which setting has begun since it weakens the structure.

Mix dry ingredients of concrete/mortar thoroughly before adding water.



Once water is added to cement mortar or concrete, it must be used up in 60 minutes after which its setting begins.



Mix water in mortar/concrete and begin the use of wet mix.

Use up all mortar & concrete mix.



60 Minutes



6

B. Rules for Cement Application (cont.)

1. Cement Selection

43 Grade cement is preferred over 53 Grade cement for the construction of houses and small infrastructure buildings.



2. Curing of Cement Mortar/Concrete

Cement mortar becomes stronger by keeping it wet



continuously without letting it dry. Keep it wet for a minimum 10 days and to get maximum strength keep it wet for 28 days.

C. Rules for Sand Application

1. Sand must be angular and not rounded.
2. Use fine sand only for plastering.
3. Sieve sand to remove small pebbles.
4. Silt content in sand should not be more than 10%
5. Remove silt by pouring sand against wind or by washing



To check silt content in sand put some sand in a transparent jar, add water, shake it well and put it down so that all of it settles down and water becomes clear. The thickness of very fine powder at the top divided by the total thickness of soil in the jar gives the % of silt in the soil.



D. Rules for Aggregate Application

1. Do not use aggregates larger than 30mm (1¼").



2. Do not use round aggregate from river in concrete. It has poor bond with cement and so it produces weaker concrete.



E. Rules for Steel Application

6

Steel helps increase the strength of the structure if the rules of its correct use are followed. But it is not necessary that more steel one uses, the stronger the building becomes.

Concrete Cover



Steel used in RC slab must have a minimum clear concrete cover of 15mm.

Steel rods must be fully encased in concrete to utilize full strength of steel rod.

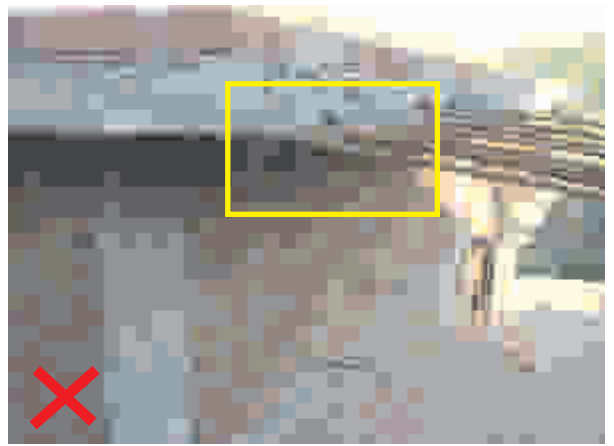

Bar-to-Bar Connection

Never connect two rods through hooks at their ends.



Connect one steel rod to another through an overlapping joint. Overlap length to be 50xBar Diameter long, and tied at four to five places with binding wire.



Placement of Concrete

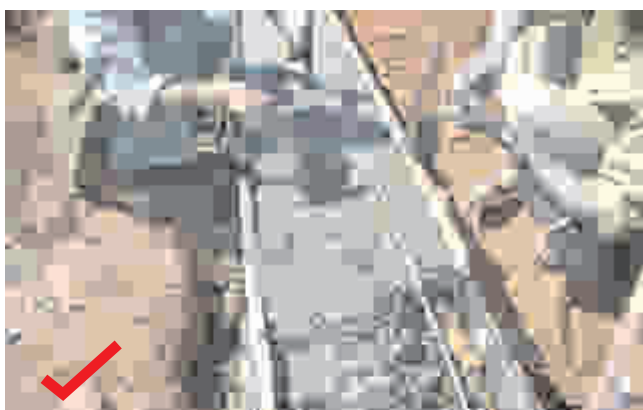

Thorough rodding of concrete must be done to minimize air pockets and water percolation to reduce corrosion possibilities.

6

F. How deep should be the Foundation ?

Decide how strong the ground is using the following simple test on dry ground.

- Remove top 150mm (6") of soil and all the fill so that virgin soil is exposed
- Take a crow bar 1540mm (60½) long and weighing 4.5 kg.
- Hold it vertical with its sharp point towards ground at 600mm (24") above the ground.
- Drop it, ensuring that it falls vertically.
- Based on the penetration of the bottom end determine if soil is hard or soft.



Soft Soil - Minimum
90 cm (3')

Hard Soil- Minimum
60 cm (2')

Rock- 7.5 to 10 cm
(3" to 4")

Decide the foundation depth depending upon how strong the ground is.

Remove all loose materials including water from foundation trench and compact the bottom before constructing foundation.

Backfill in the foundation trench must be properly compacted.

G. Foundation Masonry

Follow all rules of masonry construction given in this chapter in the construction of foundation.

Make "Strip" foundation under the wall that is wider than wall.

- Foundation Masonry Width
- Hard Soil
- Width = 2 x Wall Thickness
- Soft Soil
- Width = 3 x Wall Thickness

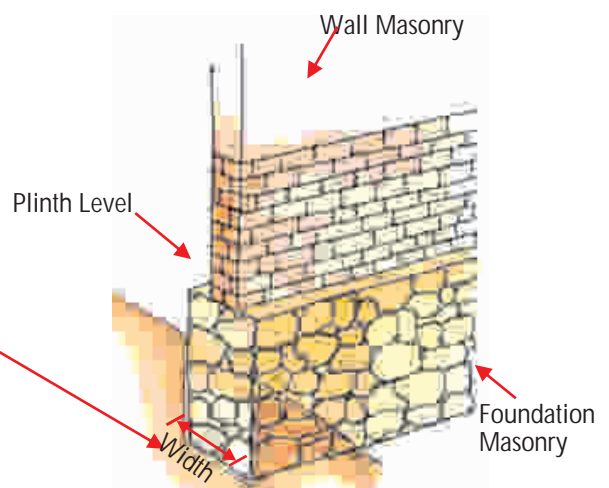

6

H. General Rules of Masonry - For Brick, Concrete Blocks & Stone

1. Wall-to-Wall Connection



1. Do not build only corners of a house at first or just one wall at a time.

2. Build all the walls at the same time along with the corners to ensure strong connection between them.

3. If this is not followed then leave the end of the wall in stepped manner.

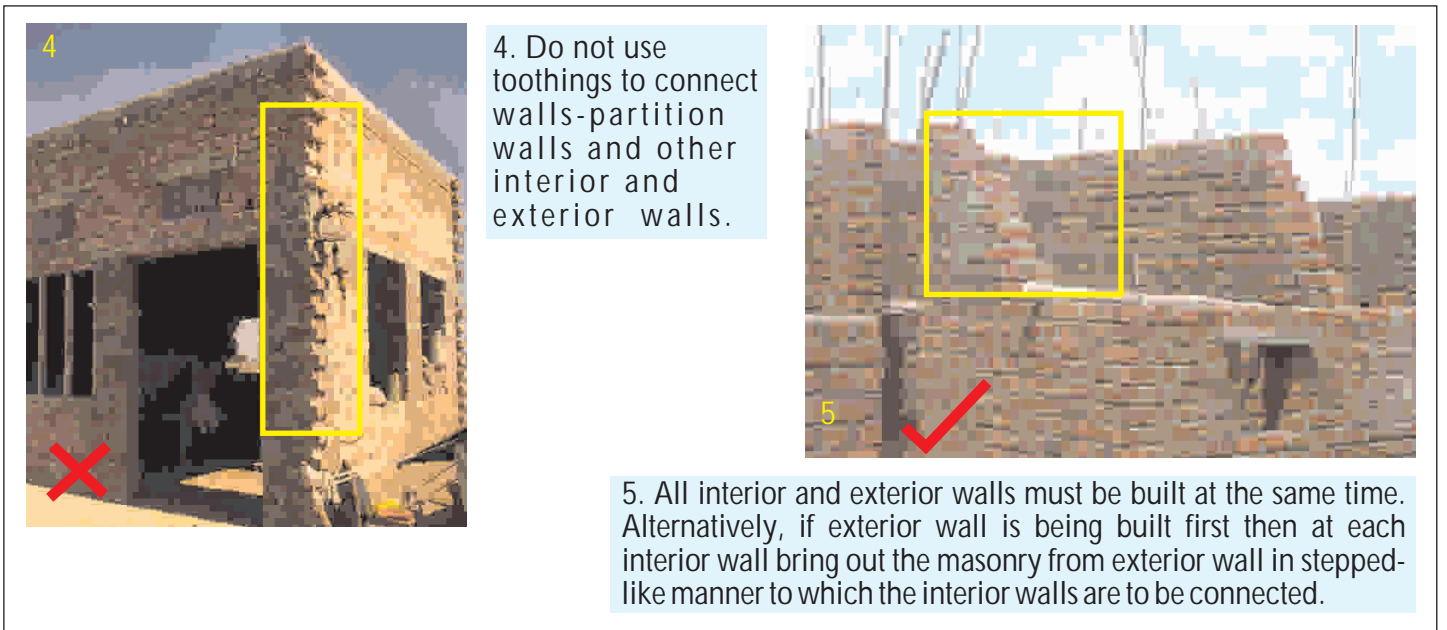

4. Do not use toothings to connect walls-partition walls and other interior and exterior walls.

5. All interior and exterior walls must be built at the same time. Alternatively, if exterior wall is being built first then at each interior wall bring out the masonry from exterior wall in stepped-like manner to which the interior walls are to be connected.

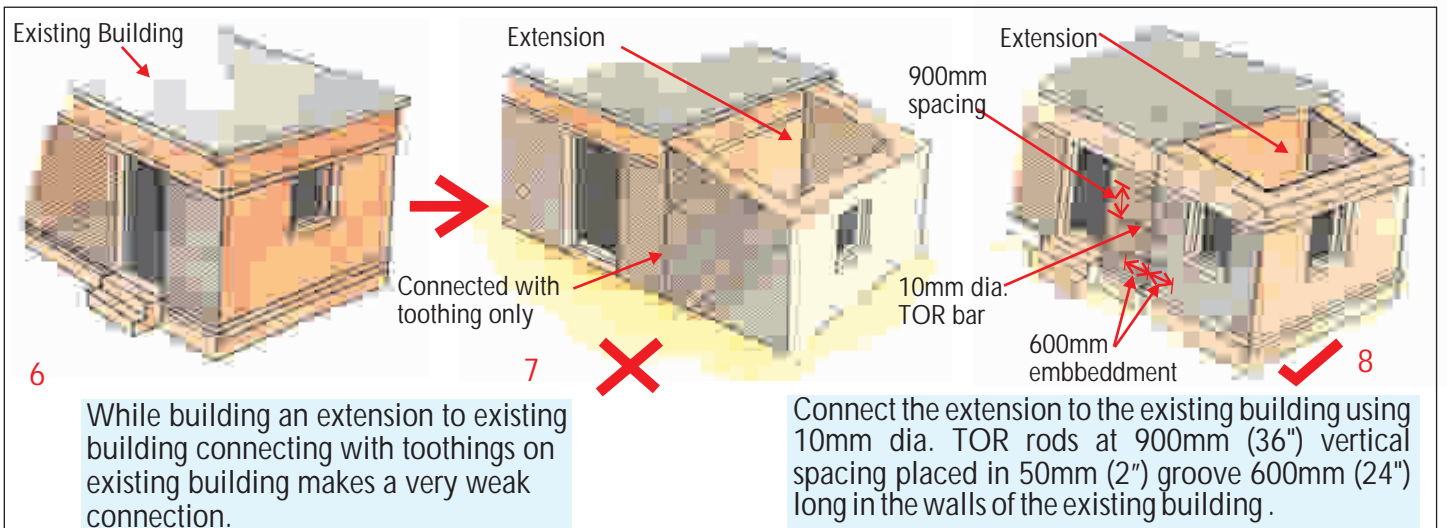

6. While building an extension to existing building connecting with toothings on existing building makes a very weak connection.

8. Connect the extension to the existing building using 10mm dia. TOR rods at 900mm (36") vertical spacing placed in 50mm (2") groove 600mm (24") long in the walls of the existing building.

H. General Rules of Masonry - For Brick, Concrete Blocks & Stone (cont.)

2. Wetting Concrete Blocks, Soft Stone and Bricks



Thoroughly soak Brick, Concrete Block or soft Stone in water when using them with cement mortar to ensure strong masonry.

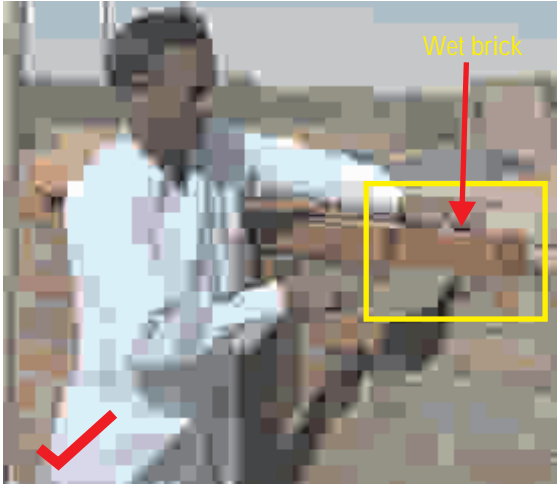

3. Using Tube Level, Plumb Bob & String for Placing Next Course



Use tube level in every second or third course to maintain uniform thickness of mortar.



Use plumb bob while beginning each new course at the corner to ensure that the wall is in plumb.



Use stretched string in every course to ensure that wall remains in plumb.

4. Vertical Joints



Break all the vertical joints.

All vertical joints must be 10mm to 15mm wide, and must be filled properly with mortar.



6

H. General Rules of Masonry - For Brick, Concrete Blocks & Stone (cont.)

5. Placing Mortar



Place mortar on top of a masonry course only when ready to put the next course.



Mortar left on top of masonry, if hard, has to be chipped off before placing mortar for the next course, to ensure good bond. This is a waste of mortar and labour.

6. Mixing of Different Materials in Masonry Work



Do not use different materials next to each other at the same level.



Material in the masonry can be changed at different horizontal levels, if necessary.

Such a change can be made at:

- Plinth Level

I. Rules For Brick Masonry

1. Do not use bricks that are inadequately fired.



2. Always place bricks with its frog (groove mark) facing up to ensure better bond with mortar.

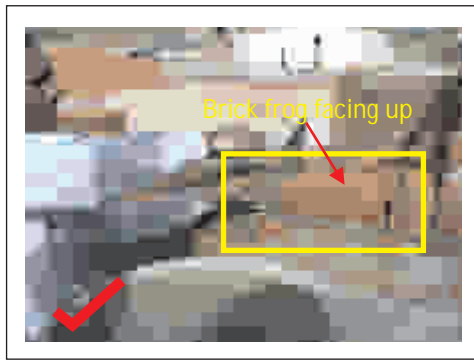

3. Foundation & Wall Thickness

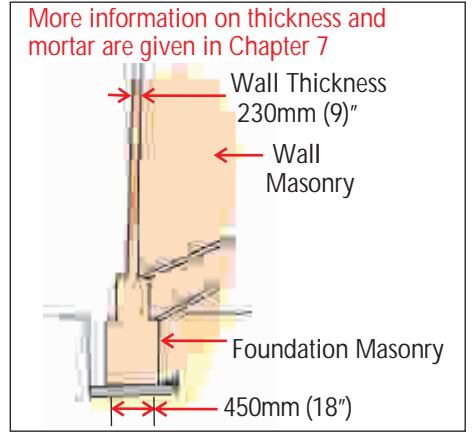

- 4. Tap the bricks and hear the metallic sound to make sure that bricks are well fired.
- 5. Do not use over-burnt bricks for walls. Plaster does not stick well on such bricks.
- 6. Bonding for Brick Wall-to-Brick Wall Junctions.

"L" & "T" junctions must be constructed as shown here to ensure strong wall-to-wall connection.

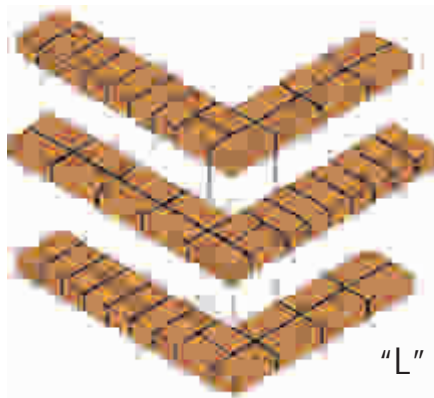

230mm (9") Wall

"L" Junction

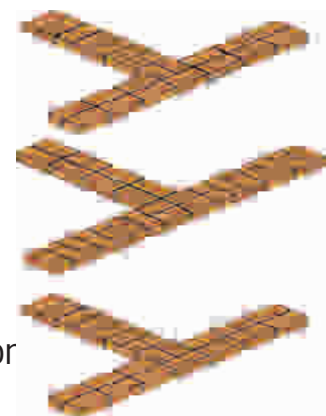

"T" Junction

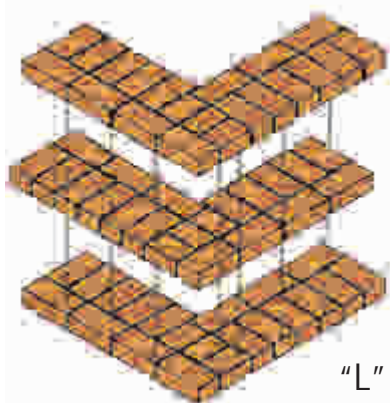

340mm (13 1/2 ") Wall

"L" Junction

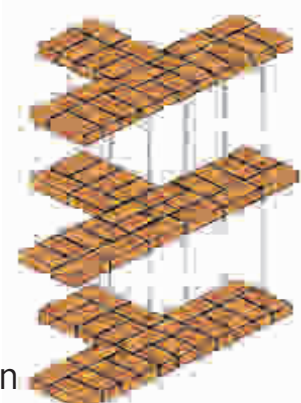

"T" Junction

6

J. Rules For Concrete Block Masonry

1. Foundation & Wall Thickness

More information on thickness and mortar are given in Chapter 7

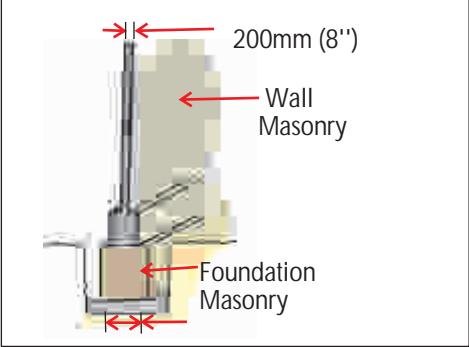

2. Dimensions & Types of Concrete Block

Solid Concrete Block should be no bigger than 300x200x150mm(12"x8"x6") so that it can easily be carried by one person.

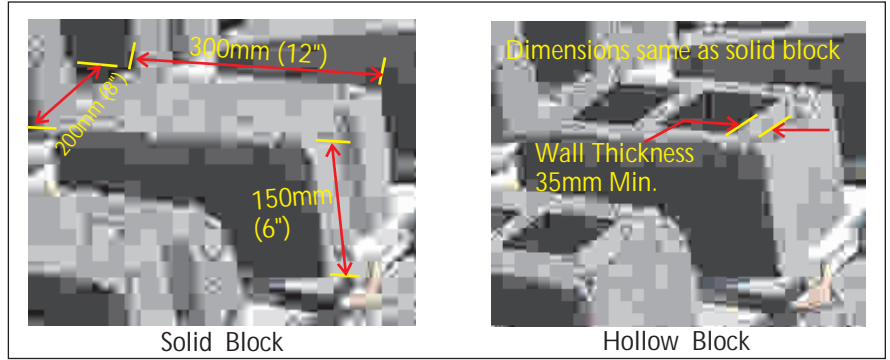

3. The top and bottom surfaces must be rough for good bond.

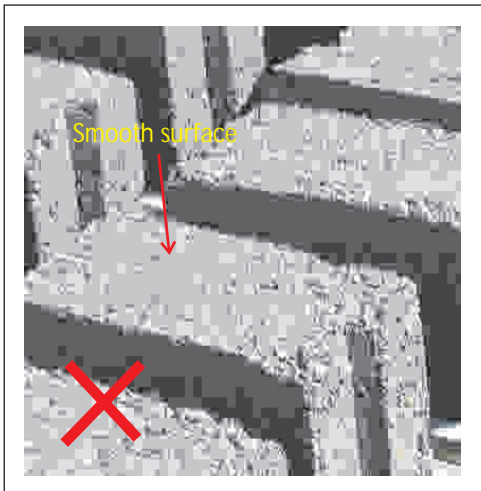

4. The blocks should be strong with strong edges.

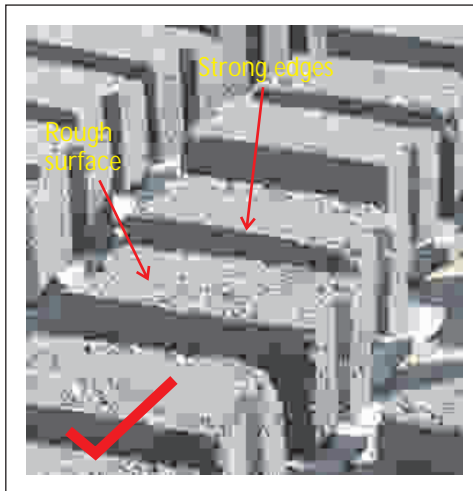

5. If blocks are freshly made then they must be cured.



6. Bonding for Block Wall-to-Block Wall Junctions.

"L" & "T" junctions must be constructed as shown here to ensure strong wall to wall connection



"L" Junction

"T" Junction

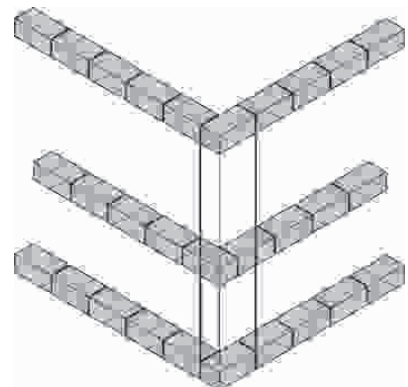

K. Rules For Stone Masonry

1. Stone Placement



Place each stone flat on its broadest face.

2. Corner Stone Placement



Place long stones at corner in each course with length of stone placed parallel to the length of that wall.

3. Foundation and Wall Thickness

More information on thickness and mortar are given in Chapter 7

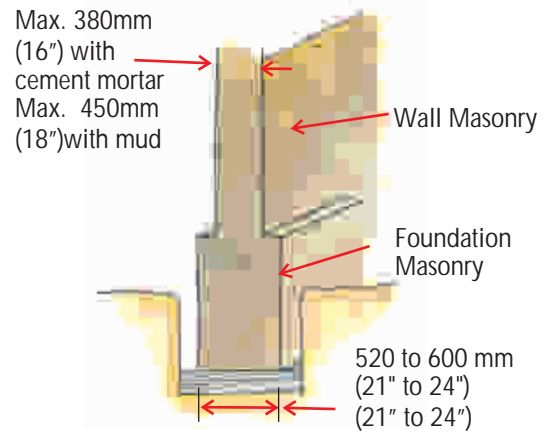

4. Interlocking of Faces



Both faces must interlock with to each other to form one wall. The vertical joint must be broken.

Broken vertical joint

Through Stone



Place length of the stones in to the thickness of wall to ensure interlocking of inside and outside faces of the wall .



5. Through Stone Placement

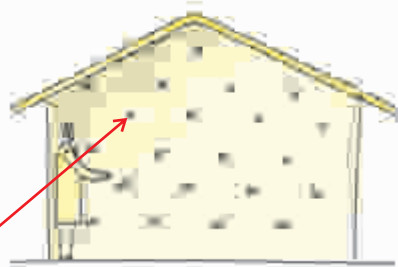

Provide at least one "through stone" at every 1200mm(4'-0") horizontal distance in masonry and at every 600mm(2'-0") height in staggered manner.

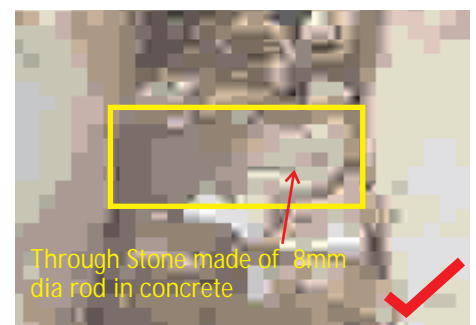

When long stones are not available, make reinforced concrete "Through Stones" with a hooked 6mm dia. rod.

6

K. Rules for Stone Masonry (cont.)

6. Courses in Stone Masonry

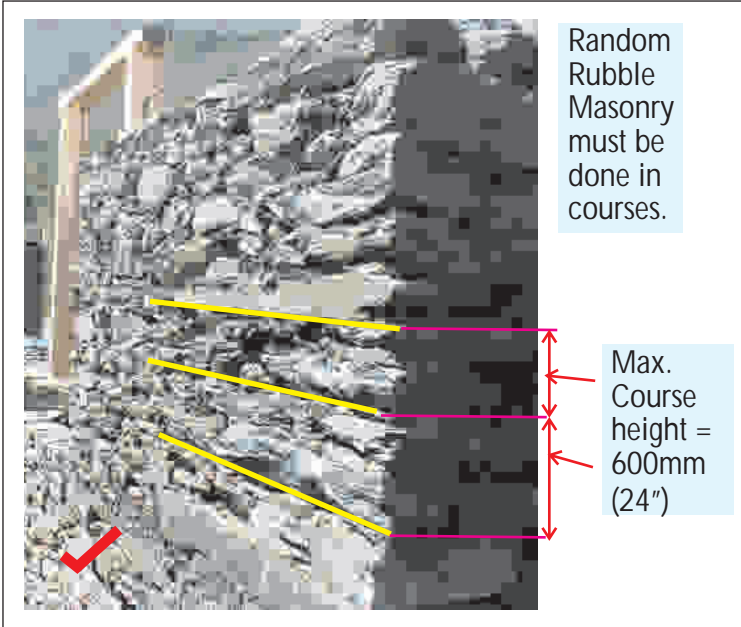

7. Voids in Stone Masonry

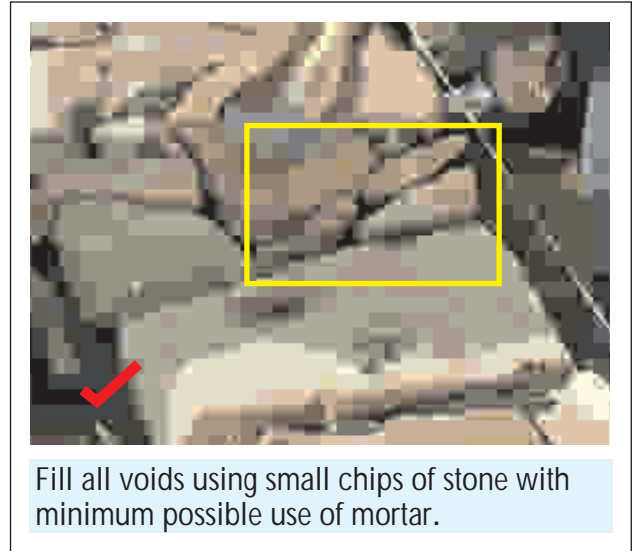

8. Use of Round Stone



Stone must be broken to make it angular so that it has no rounded faces.

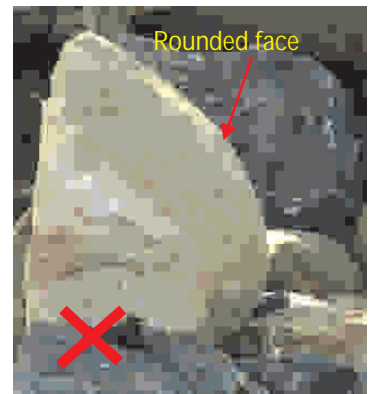

9. Stone Masonry Below Ground

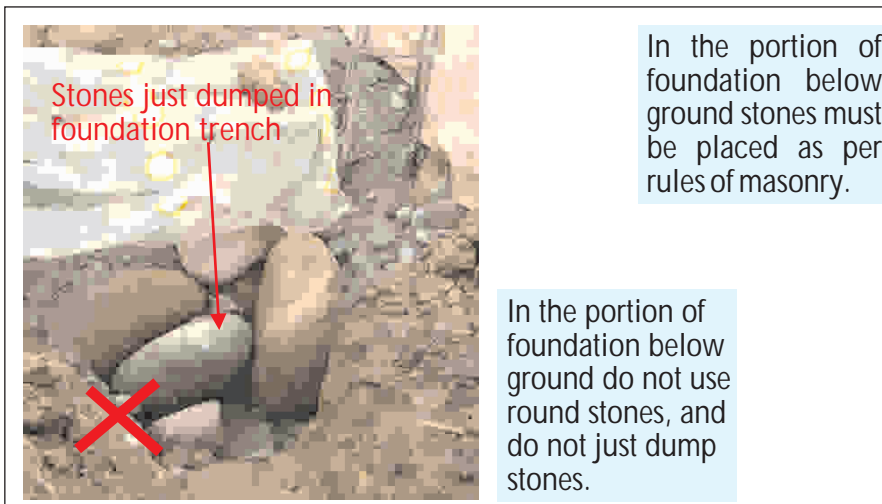



To reduce the death and destruction arising out of natural hazards, a building must be so built that it resists the forces of the hazards expected in future. It is important to ensure this approach with **every new building**.

For every new building to be disaster resistant the construction technology has to be:

Scientific, Cost efficient, Easy to execute, Locally appropriate, Dependent on easily available materials and Culturally suitable

How to build a disaster resistant house that will not collapse in a disaster ?

In addition to following the **Rules of Disaster Resistant Design** and **Rules of Good Quality Construction**, one must follow the **Special Rules for Masonry Walls** given here, and include **Disaster Resisting Features** in the new construction as shown here to eliminate all the weaknesses present in the building as shown in Chapter 4

1. Special Rules for Masonry Walls for Earthquake Resistant Construction For Seismic Zones III, IV & V

A. Stone Masonry Walls

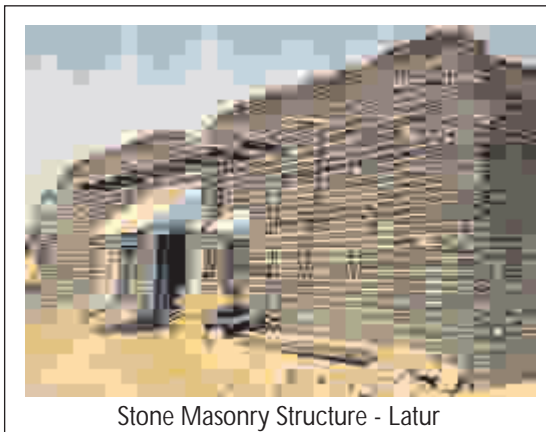

Stone Masonry Structure - Latur



Stone Masonry Structure - Uttarakhand

7

A. Stone Masonry in Mud Mortar

If the water for curing mortar is not available then build walls in good quality mud mortar.

Permitted in Seismic Zone III, IV & V

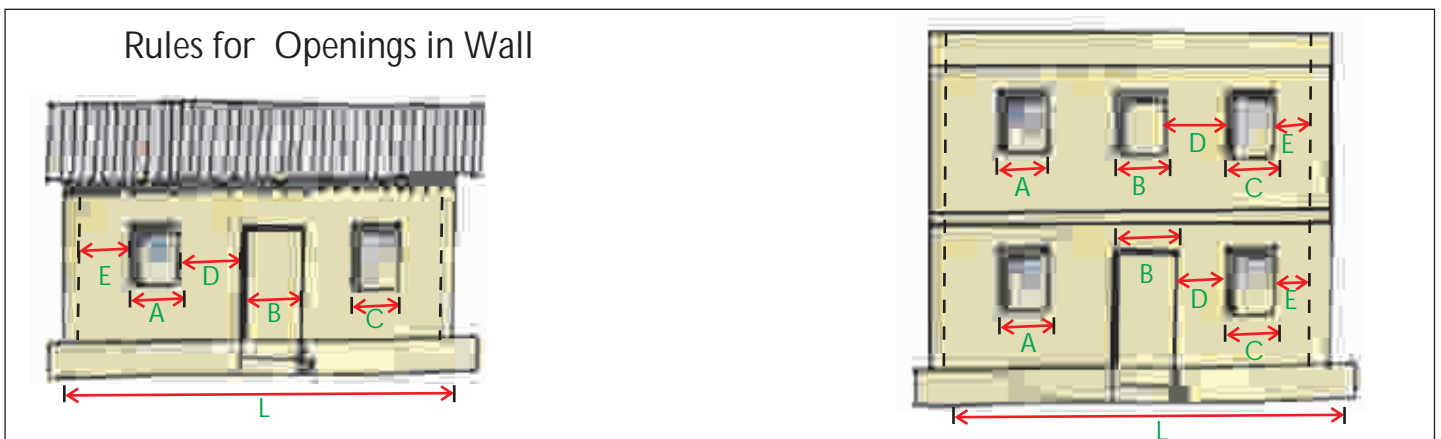
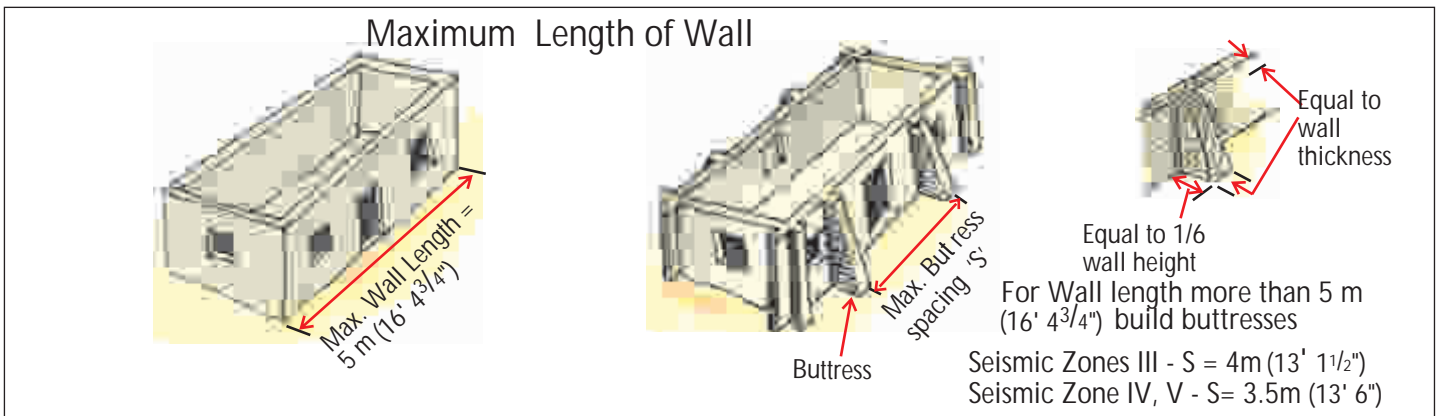
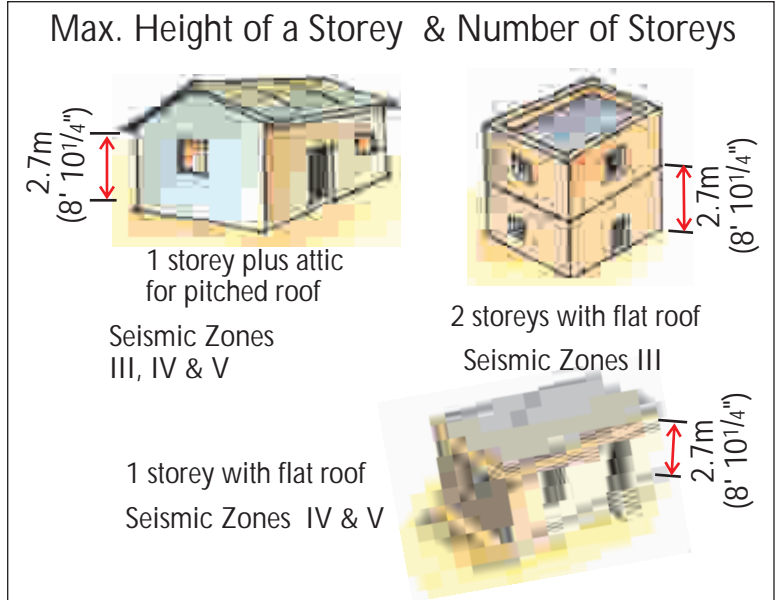
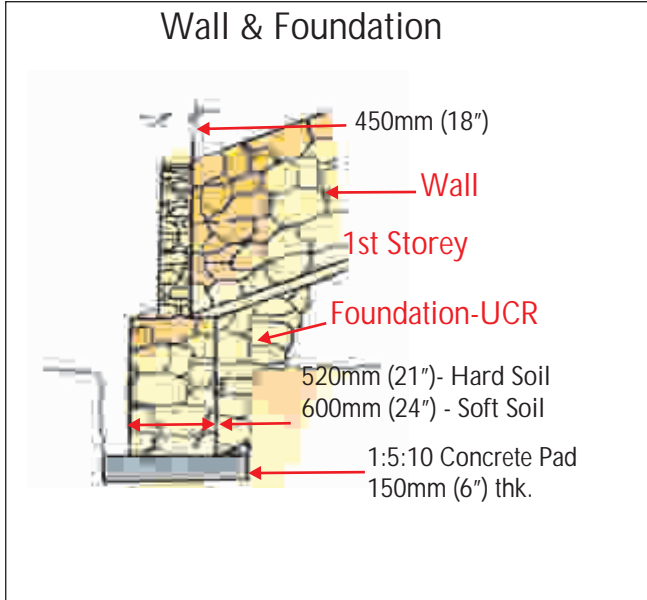

Zone	(A+B+C) as % of L	D	E	Max. no. of Storeys
III	46% max.	450mm(18") min.	450mm(18") min.	1
III	33% max.	450mm(18") min.	450mm(18") min.	2
IV, V	33% max.	600mm(24") min.	600mm(24") min.	1

B. Stone Masonry in Cement Mortar

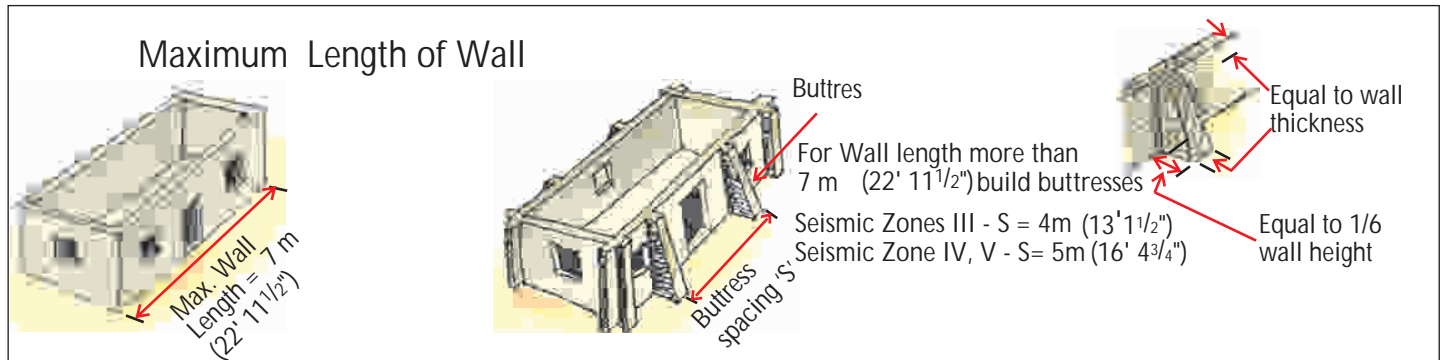
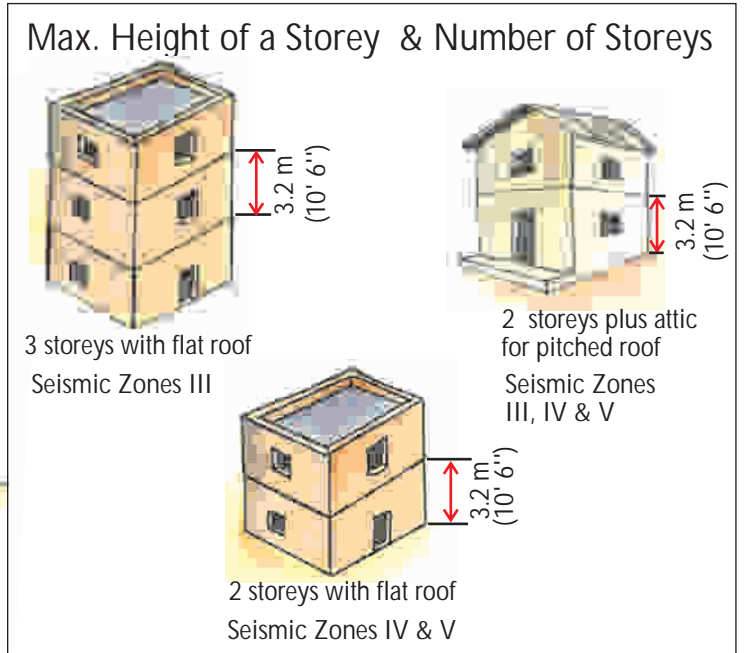
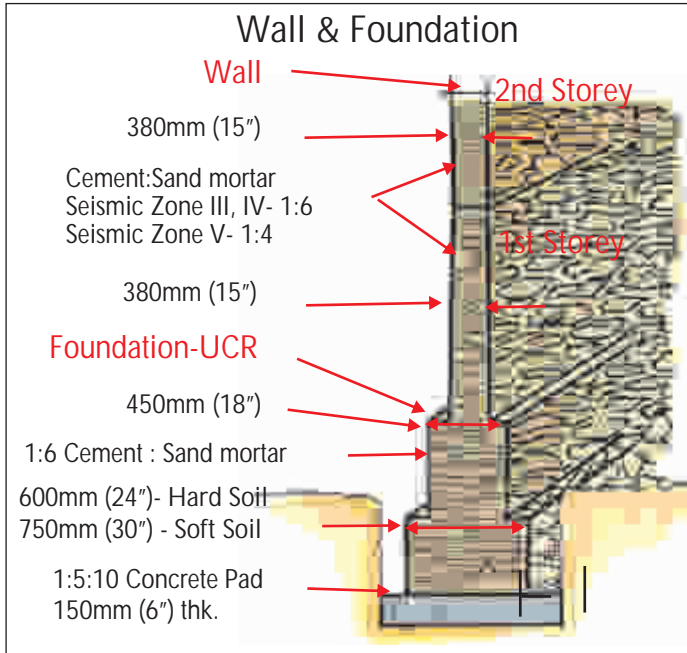

Rules for Openings in Wall

Zone	(A+B+C) as % of L	D	E	Max. no. of Storeys
III	50% max.	450mm(18") min.	230mm(9") min.	1
III	42% max.	450mm(18") min.	230mm(9") min.	3
IV, V	50% max.	600mm(24") min.	450mm(18") min.	1
IV, V	42% max.	600mm(24") min.	450mm(18") min.	2

7

C. Brick Masonry in Mud Mortar

If the water for curing mortar is not available then build walls in good quality mud mortar.

Permitted in Seismic Zone III, IV & V

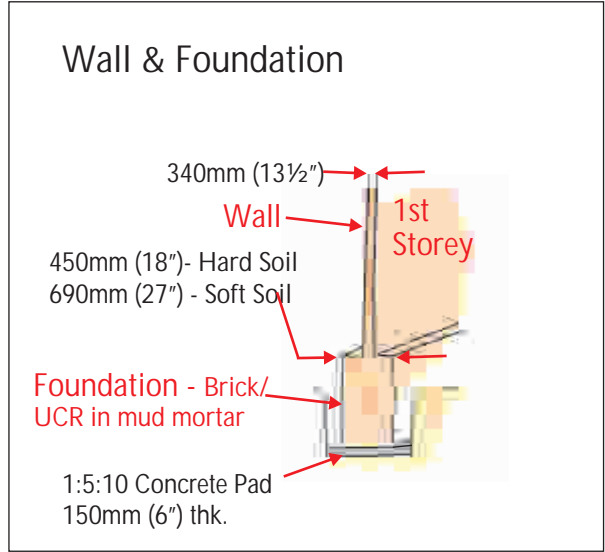

Max. Height of a Storey & Number of Storeys



1 storey plus attic for pitched roof
Seismic Zone III, IV & V

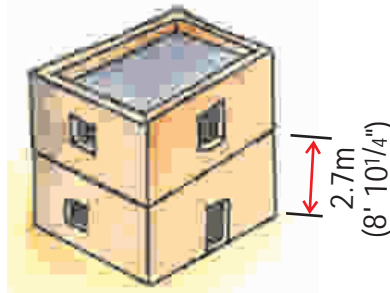

2 storeys with flat roof
Seismic Zone III

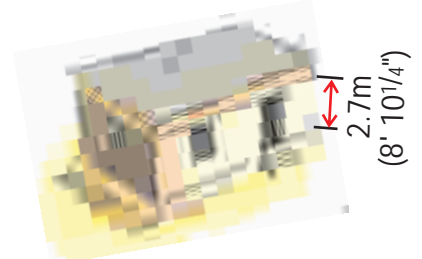

1 storey with flat roof
Seismic Zone IV & V

Maximum Length of Wall

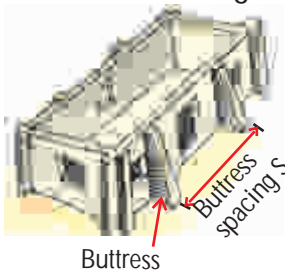
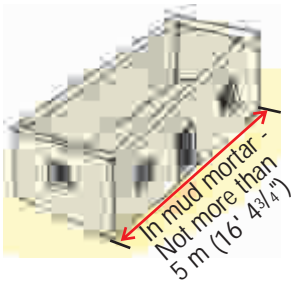

For Wall length more than 5 m (16' 4¾") build buttrusses

Seismic Zones III, IV & V - S = 5m (16' 4¾")

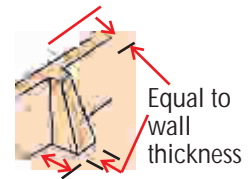

Equal to 1/6 wall height

Rules for Openings in Wall

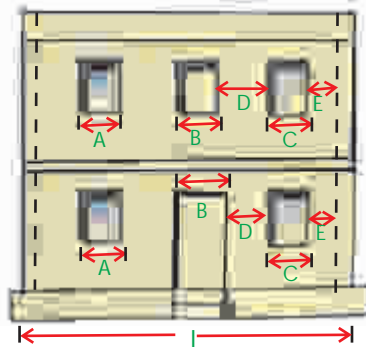

Zone	(A+B+C) as % of L	D	E	Max. no. of Storeys
III	46% max.	450mm(18") min.	450mm(18") min.	1
III	33% max.	450mm(18") min.	450mm(18") min.	2
IV, V	33% max.	600mm(24") min.	600mm(24") min.	1

D. Brick and Concrete Block Masonry in Cement Mortar

Brick In Cement Mortar

230mm (9")

230mm (9")

230mm (9")

340mm (13½")

450mm (18") - Hard Soil
690mm (27") - Soft Soil

1:5:10 Concrete Pad
150mm (6") thk.

1:6 Cement:SandMortar

Cement:Sand mortar
Zone III, IV: 1:6
Zone V: 1:4

1:6 Cement:SandMortar

Foundation -Brick/
UCR in 1:6 Cement :
Sand mortar

Wall

2nd Storey

1st Storey

Concrete Block In Cement Mortar

200mm (8")

200mm (8")

200mm (8")

300mm (12")

450mm (18") - Hard Soil
500mm (20") - Soft Soil

1:5:10 Concrete Pad
150mm (6") thk.

1:4 Cement:Sand mortar
1:6 Cement:Sand mortar

Foundation -
UCR in 1:6
Cement : Sand mortar

Wall

2nd Storey

1st Storey

OR

300mm (12")

400mm (16") - Hard Soil
500mm (20") - Soft Soil

1:5:10 Concrete Pad
150mm (6") thk.

1:4 Cement:Sand mortar
1:6 Cement:Sand mortar

Foundation-
Concrete Blocks in 1:6
Cement : Sand mortar

7

D. Brick and Concrete Block Masonry in Cement Mortar (cont.)

Max. Height of a Storey & Number of Storeys



2 storeys plus attic for pitched roof
Seismic Zone III, IV & V

3 storeys with flat roof
Seismic Zone III, IV & V

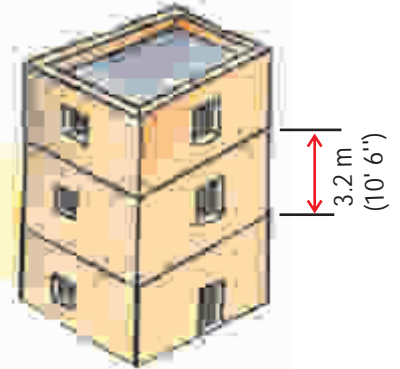

Maximum Length of Wall

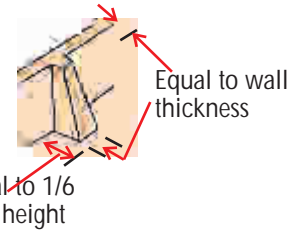
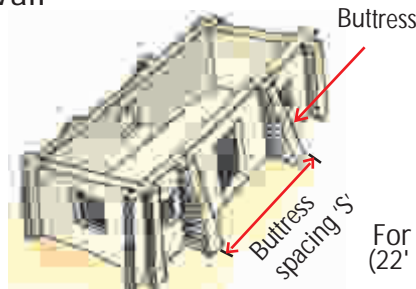
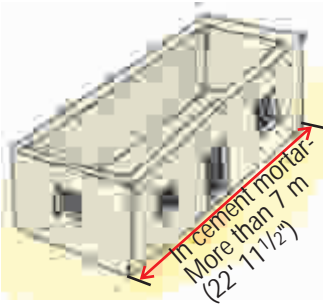

For Wall length more than 7 m (22' 11 1/2'') build buttresses

Seismic Zones III, IV & V - S = 5m (16' 4 3/4'')

Rules for Openings in Wall

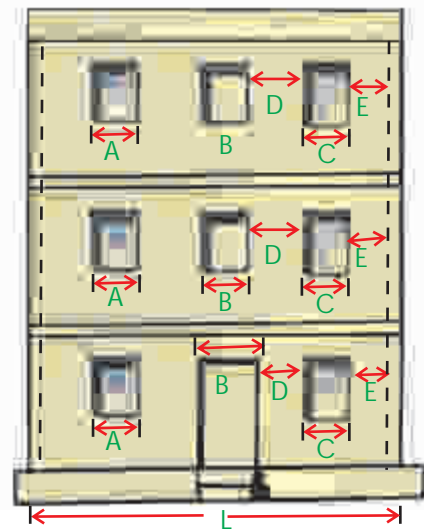
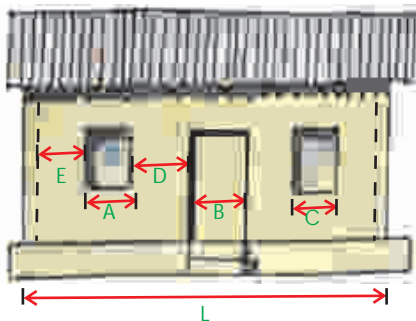

Zone	(A+B+C) as % of L	D	E	Max. no. of Storeys
III	50% max.	450mm(18") min.	230mm(9") min.	1
III	42% max.	450mm(18") min.	230mm(9") min.	3
IV, V	50% max.	560mm(22") min.	450mm(18") min.	1
IV, V	42% max.	560mm(22") min.	450mm(18") min.	2

2. Special Rules for Masonry Walls for Cyclone Resistant Construction For Wind Speed Zone III & IV (Wind Speeds from 47 to 55m/second)

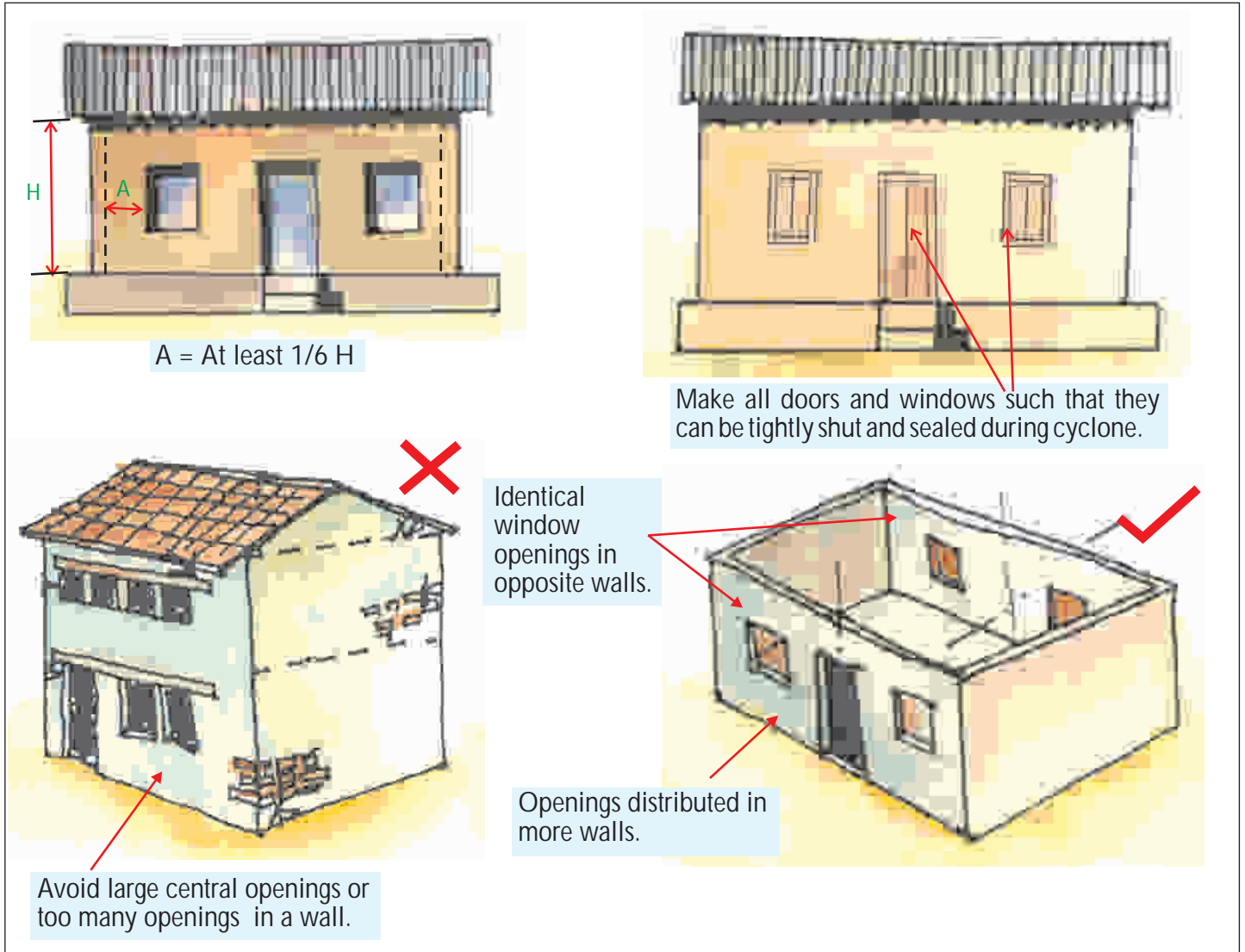

A = At least $\frac{1}{6} H$

Make all doors and windows such that they can be tightly shut and sealed during cyclone.

Avoid large central openings or too many openings in a wall.

Identical window openings in opposite walls.

Openings distributed in more walls.

3. Special Rules for Masonry Walls for Flood Resistant Construction

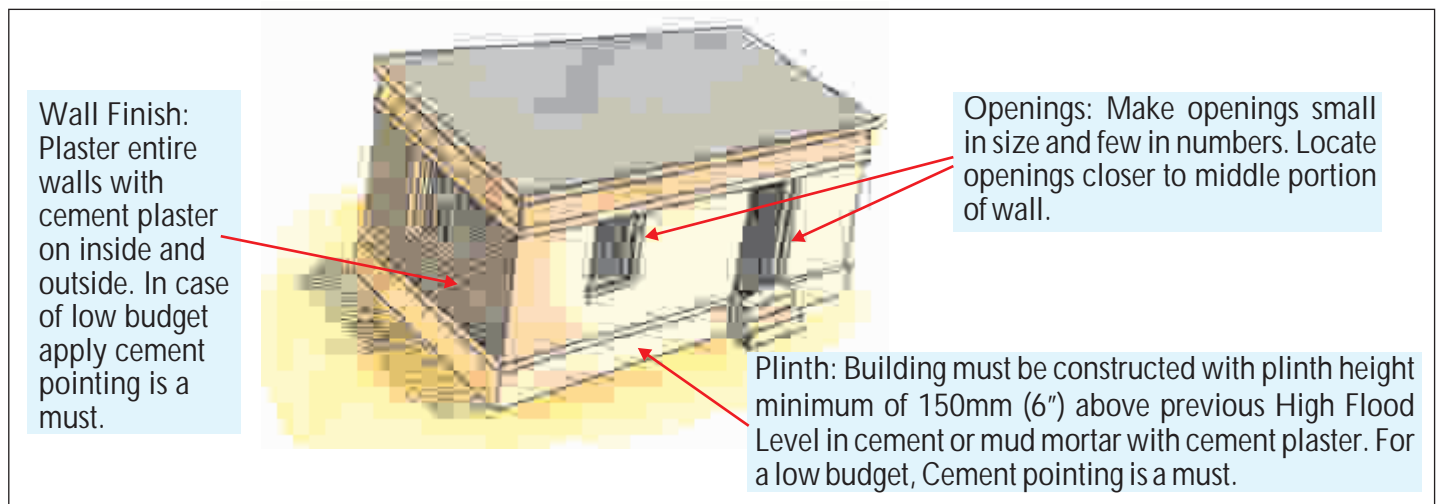

Wall Finish: Plaster entire walls with cement plaster on inside and outside. In case of low budget apply cement pointing is a must.

Openings: Make openings small in size and few in numbers. Locate openings closer to middle portion of wall.

Plinth: Building must be constructed with plinth height minimum of 150mm (6") above previous High Flood Level in cement or mud mortar with cement plaster. For a low budget, Cement pointing is a must.

7

SPECIAL DISASTER RESISTING FEATURES FOR NEW CONSTRUCTION

The Disaster Resisting Features for the most commonly used building systems are shown below at a glance. This is followed by the detailed description.

Disaster Resisting features at a glance

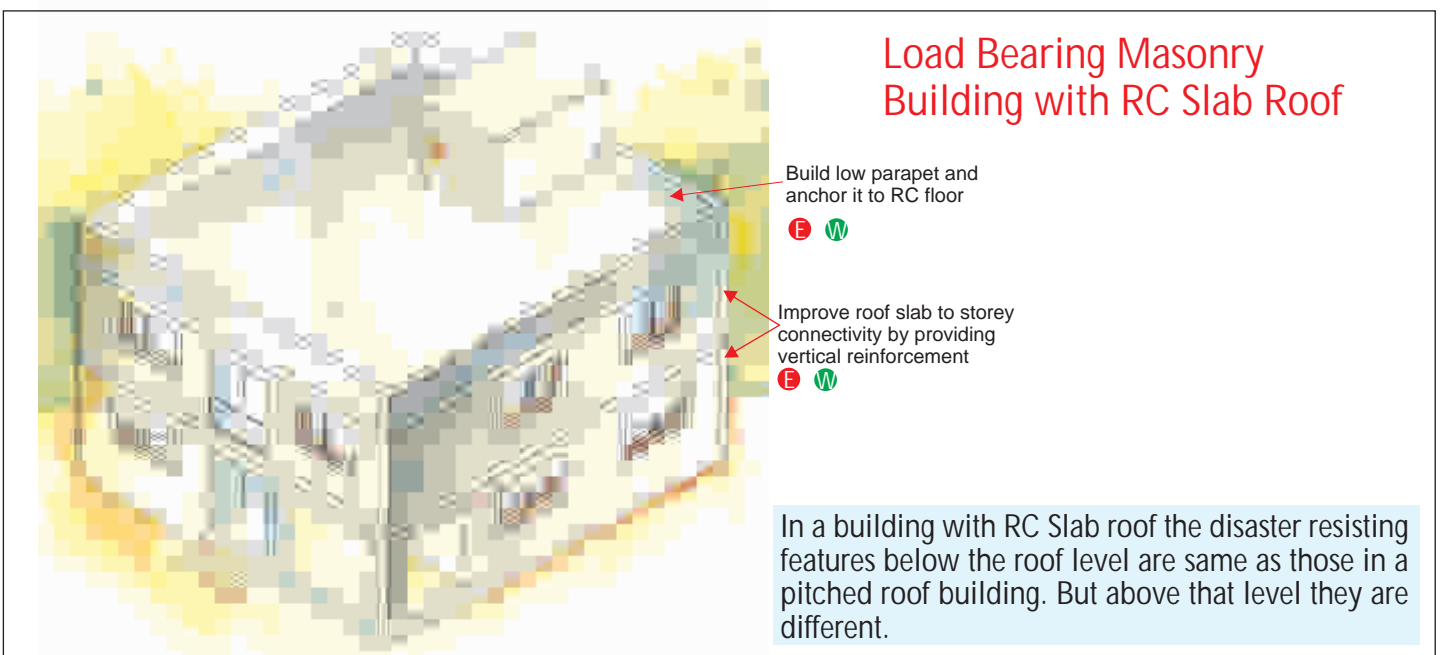
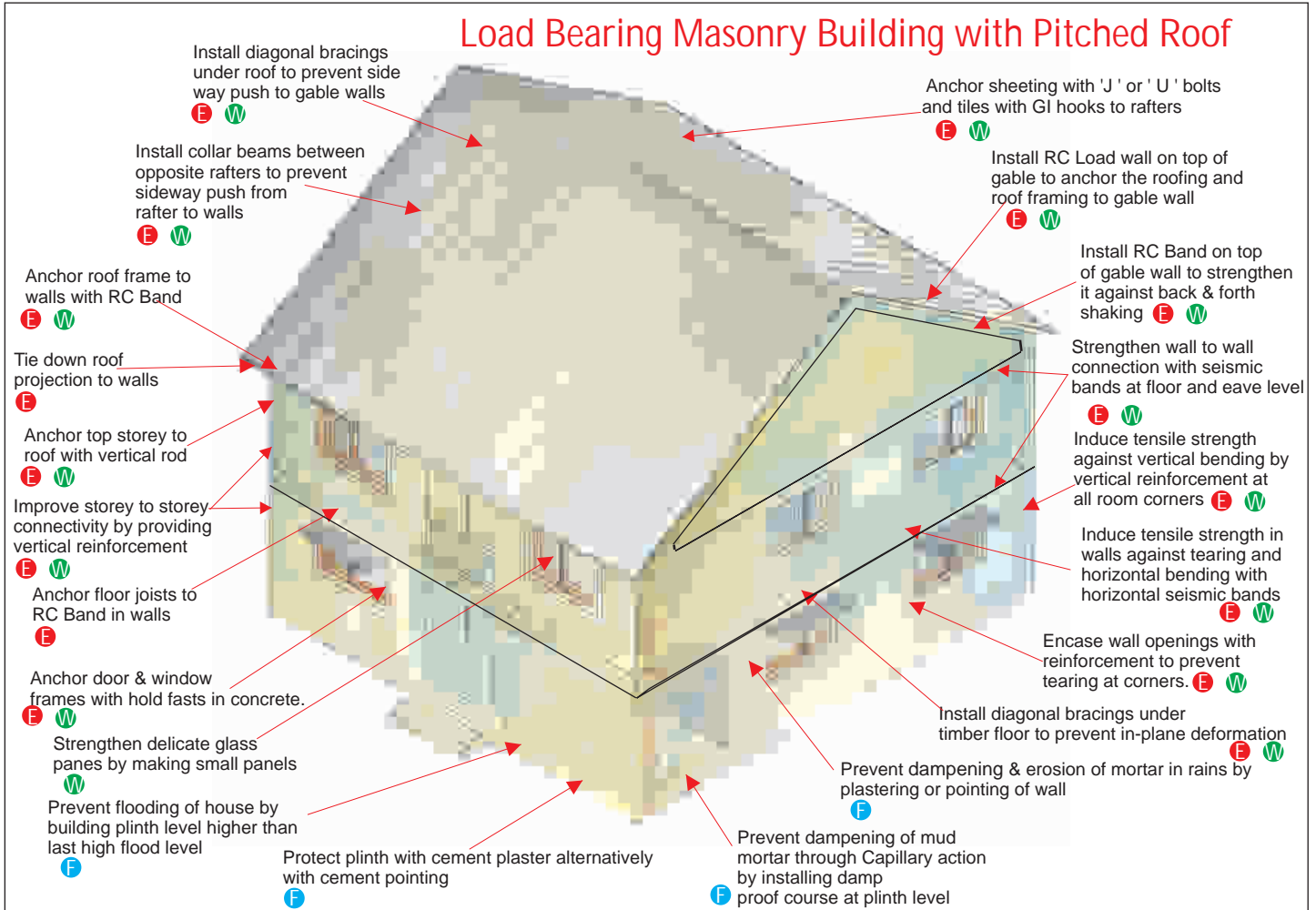

1 Install Corner Vertical Reinforcement in Masonry Wall



Disaster Type: **E** **W**

Where to apply remedy? :

Weaknesses In Masonry Walls:

- (a) Weak wall-to-wall connection.
- (b) Absence of ductility in vertical direction.
- (c) Absence of connection between storeys.
- (d) Absence of connection between top storey and roof or RC slab.

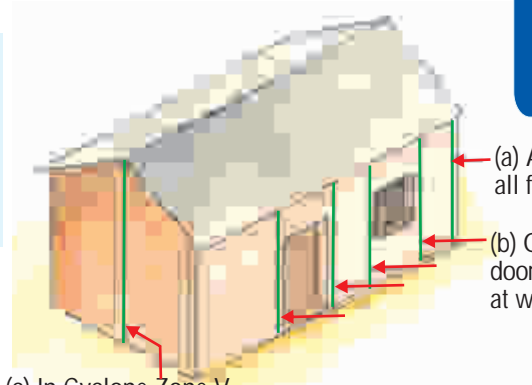

- (a) At each room corner on all floors
- (b) On either side of door openings, and preferably at window openings.

(c) In Cyclone Zone V under the ridge in gable wall

Vertical bar must be installed at foundation level and go up to the roof.

Specifications:

	Seismic Zone III & IV and Wind Speed Zone III	Seismic Zone V & Wind Speed Zone IV
Ground storey of 1storey building and upper storey of 2 storey building	10mm TOR*	12mm TOR
Ground storey of 2 storey building	12mm TOR*	16mm TOR
Plus place one vertical bar at spacing no greater than 2000mm (6'-6") in a wall.		
* In Seismic Zone III in single storey building no vertical steel is required.		

How? :



1
Pour 75mm (3") of 1:2:4 concrete in the foundation pit for providing base and mark the exact location for each bar with plumb bob.



2
Place at marked location 'L' shaped vertical rod with bent portion having the length of 450mm (18").



3
Place additional 75mm (3") of concrete over the bent portion of the bar.

Support the bar until concrete hardens.

Cure with water for at least 3 days before starting the construction above.

7

In Random Rubble Walls

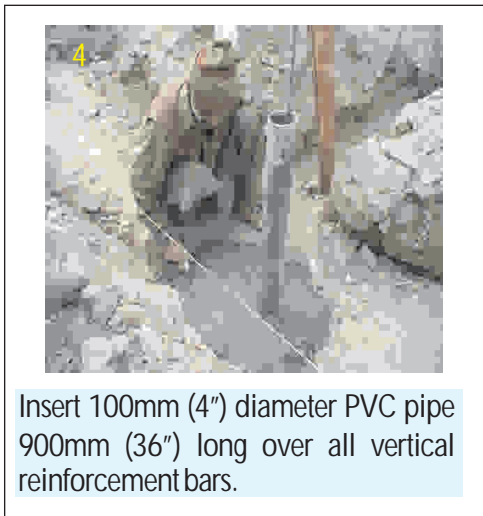

Insert 100mm (4") diameter PVC pipe 900mm (36") long over all vertical reinforcement bars.



Construct stone masonry up to 450mm (18") height keeping pipe piece in place.



Pull out the pipe and fill up the cavity with 1:1½:3 micro concrete for Zone IV & V and 1:2:4 micro concrete for Zone III while continuously rodding. Ensure min.50mm (2") concrete all around the bar. Put back pipe in place and continue with masonry construction around it.

In Concrete Block Masonry

In Brick Masonry

Arrange bricks so that cavity gets formed around the bar which is filled with micro-concrete in 450mm (18") lifts.

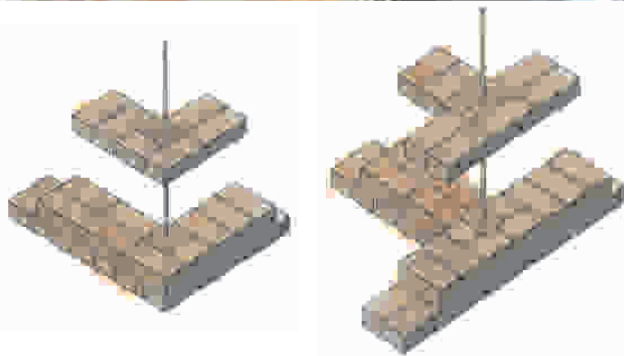

Bend the vertical rod and create overlapping joint with roof level band reinforcement or with RCC slab reinforcement.

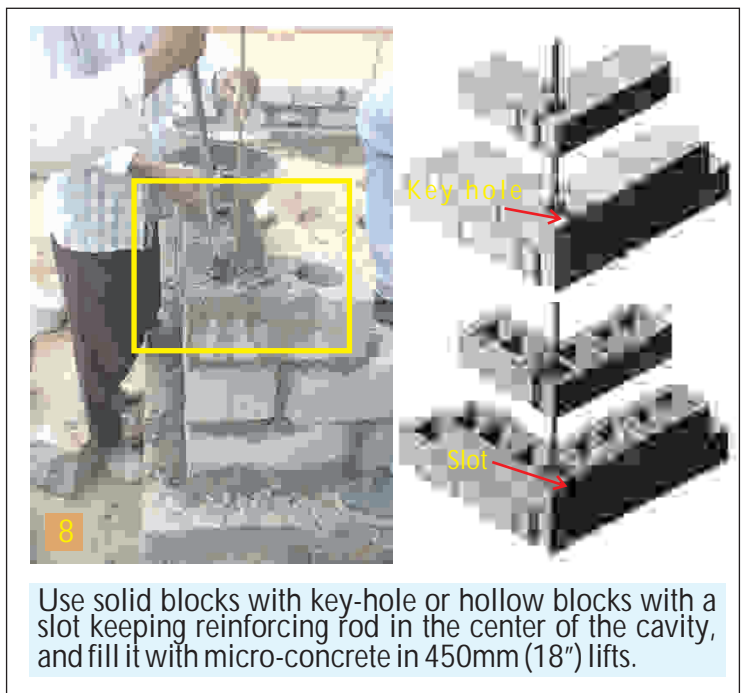

Use solid blocks with key-hole or hollow blocks with a slot keeping reinforcing rod in the center of the cavity, and fill it with micro-concrete in 450mm (18") lifts.

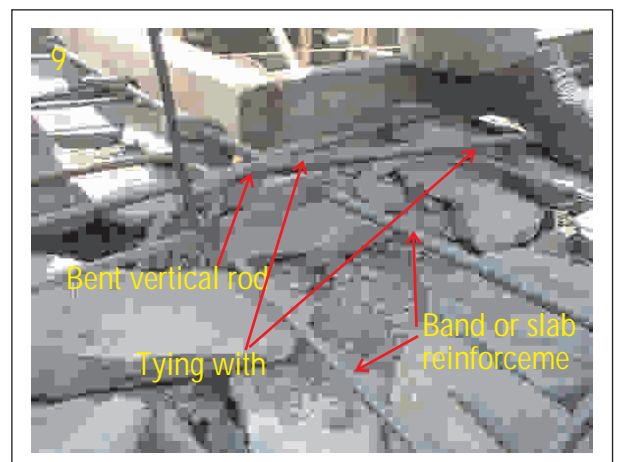

2. Install RC Band

Disaster Type: **E** **W** **F**



Weaknesses In Masonry Walls:

(a) Weak wall to wall connection; (b) Poor horizontal bending strength; (c) Poor tensile strength against tearing; (d) Poor strength of gable wall against back and forth shaking.

Where to install? :

Apply on all walls including partition walls, in an un-interrupted manner.

All bands are to be applied in Seismic Zone III, IV & V, and in Wind Speed Zones II & IV unless mentioned otherwise.

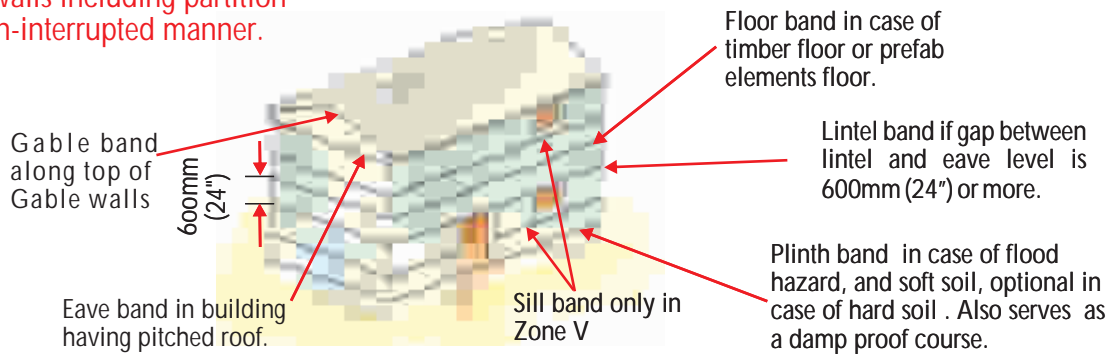

Specifications: For wall length 5m (16' 4³/₄") or less.

Cement Concrete: Cement : Sand : Aggregates in 1:1.5:3 proportions.

Band must be of full length and full width of the wall with min. 75mm (3") thickness.

	Wind Speed Zone III, Seismic Zone III, IV	Wind Speed Zone IV, Seismic Zone V
Longitudinal Reinforcing bars	2 - 8mm TOR	2 - 10mm TOR
8mm TOR cross links hooked at both ends with spacing of 200mm (8")		

How to install?



At the desired level on the wall place two longitudinal bars at 25mm (1") inside from both the wall faces and tied with cross-links.



Place the longitudinal bars at mid height of the band by inserting stone pieces.

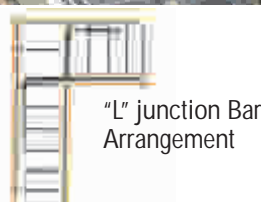
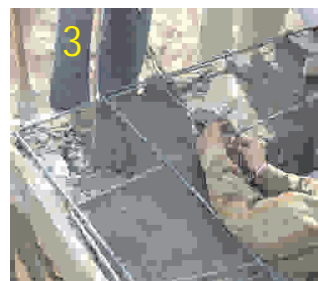

Connect bars at wall junction with minimum 450mm (18") overlaps.



Use a 'L' shaped 8mm TOR bar with both legs 450mm (18") long to tie main rebar of the band and vertical bar together.

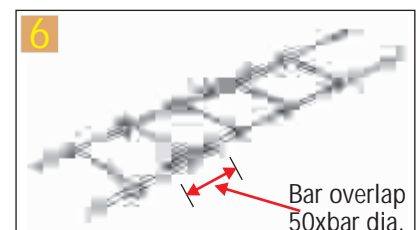
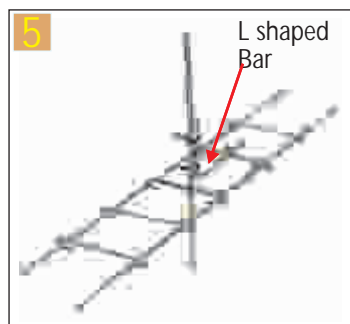

Bar-to-bar connection must be done with overlap joint 400mm (16") long for 8mm dia. Bars and 500mm (20") long for 10mm dia.

2. Install RC Band (cont.)

7

Connection of Eave to Gable Band:

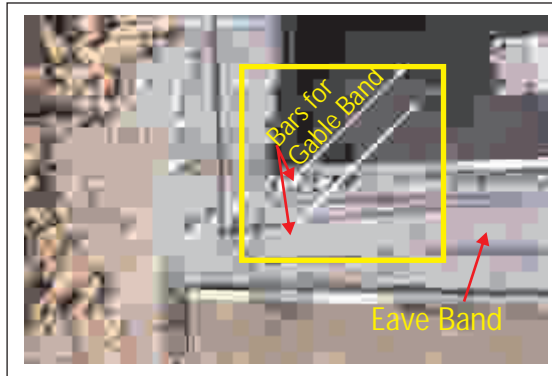

Provide two bars of same size as that in band and bent into a necessary shape to ensure an overlap of 450mm (18").

Pour concrete of 1:1.5:3 proportion with rodding. Cure band for fifteen days.

Connection of Lintel with Eave Band

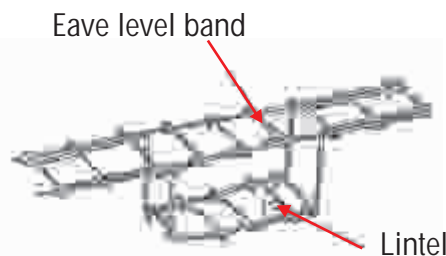

When lintel band is not installed, bars from lintel are bent upwards and tied to the rebars of eave band. Vertical portion is fully encased in concrete.

Remember: Make sure the bars in band are not cut in the corner. In an earthquake, band can break at the point where bars are cut.

Alternatives: Low-cost and simpler options

For earthen/adobe walls (Cases A & B) or masonry walls built using clay mud mortar (Case C). Note: Chemical treatment of bamboo and timber will enhance their durability 8 to 10 times.



Case A

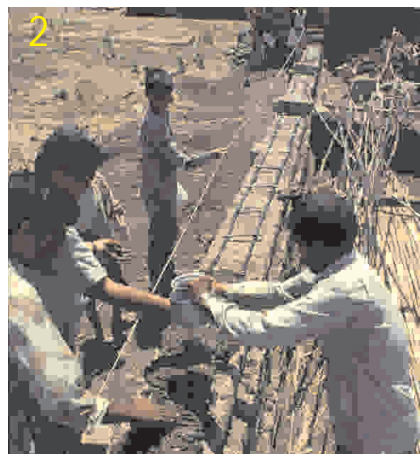

Case B

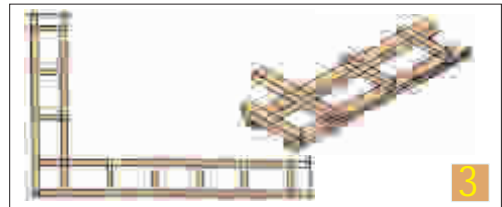

Case C

(1) Chicken wire mesh or (2) Bamboo ladder encased in 25mm (1") layer of mud mortar at several levels.

(3) Timber Band: Ensure proper overlapping joint at corner using 2 or more nails, screws or wood pegs.

3. Install RC Encasement Around Openings

Disaster Type: **E** **W**



Weaknesses In Masonry Walls: (a) Tearing at opening corners that cause diagonal cracks
 Where to Install? : On both sides of door and all around window openings

Specifications:

Door encasement: Same as Vertical reinforcement in corners.
Window encasement: Use 10mm TOR bars.
The bars to be connected to the Plinth and lintel band and continue up to eave band or the RC slab.
Use 1:1.5:3 micro-concrete

How?:

Doorway

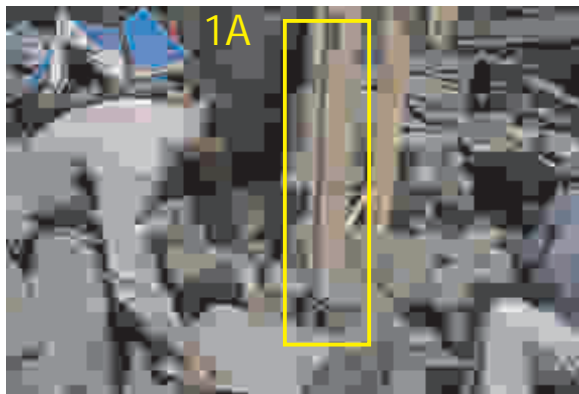

1A & B. The vertical bar starting from foundation is to be placed 50mm (2") away from the face of opening on both sides and encased in micro concrete within masonry. If at top of the door a part of the frame obstructs the bar then shift the frame as needed.

Window

Place vertical bar 50mm (2") away from the face of opening on both sides starting from plinth band or from foundation. If at top of the window a part of the frame obstructs the bar then shift the frame as needed. Bring the masonry up to 75mm 3" below the sill level.



1C. Place "U" shaped 10mm TOR bar at sill level and encase it in 75X75mm (3"x3") micro-concrete band.



2. The vertical legs are to be tied to vertical bars and encased in concrete.



3. Continue building masonry.



4. Bend vertical bar & connect to lintel band reinforcement.

7

4. Install Diagonal Bracings & Struts for Timber Intermediate or Attic Floor

Disaster Type: **E** **W**

Weakness in Flat timber Floor:
(A) Rectangle changing to parallelogram in floor.

Where to Install? : Just under the floor

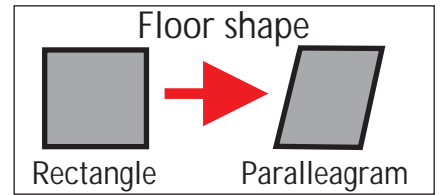

How?

1. Pre-drill planks and floor joists and use two nails at each end.



3 & 4. Install diagonal bracings of same plank.

2. Install 2- 100mm (4") x 25mm (1") struts (plank) on the underside of the floor joists adjacent to the walls that support the joists.

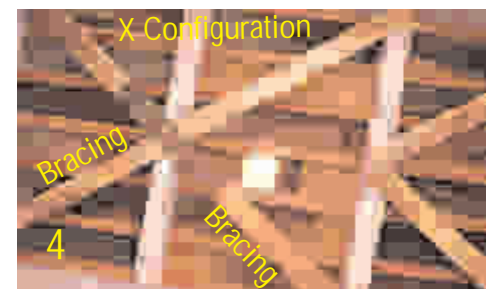

5. Anchor Timber Floor to Walls

Weakness: (a) Poor connection between timber floor and walls.

Disaster Type: **E** **W**

Where to Install? : At the junction of floor understructure and wall

How?



1. Install 100mm (4") long MS angles 35x35x3mm in the floor level band at each joist locations.

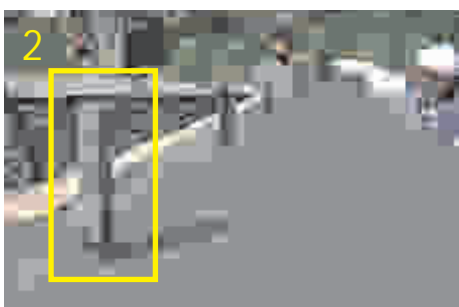

2. Angles to have two holes 14mm in diameter.



3. Connect floor joists with 2-12mm diameter bolts.

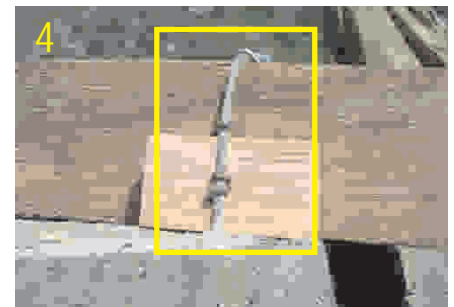

4. Alternatively install 6mm bar or 10 gauge GI wires in concrete as anchor.

6. Install Collar Beam in Rafters in Pitched Roof Support System



Disaster Type: **E** **W**

Weakness : (a) Sideways push on walls from roof rafters resting on these walls

Where to Install? : Between the opposite pairs of rafters.

Specifications: Planks to be of 35 x 100 mm with 2 pre-drilled holes of 14mm diameter.

How?

At 2/3rd height of the roof/attic install 35 x 100mm plank collar beam across the opposite rafters using 2 -12mm diameter bolts in case of Principal Rafters and using 2- 4mm diameter screws in case of Rafter.



7. Install Diagonal Bracings & Struts for Pitched Roof Framing Diaphragm

Disaster Type: **E** **W**

Weakness: In pitched roof: (a) in-plane deformation with rectangle changing to parallelogram resulting into sideways push to gable walls.

Where to Install? : On the underside of the roof framing.

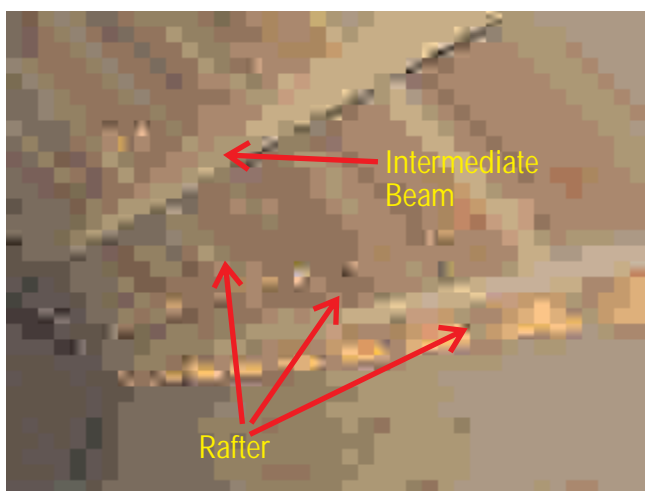
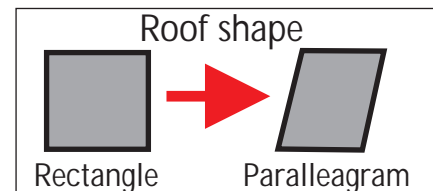

In Kutch roof there are rafters spanning from ridge beam to wall with a support over intermediate beam.



In Uttarakhand roof there are large size purlins that span from gable wall to gable wall with a support over Principal Rafter.

This difference dictates the arrangement of the bracings and struts that are to be installed for the diaphragm.

7

7. Install Diagonal Bracings & Struts for Pitched Roof Framing Diaphragm (cont.)

How?



1. Pre-drill planks and rafter /purlins.



2. Using two nails at each end install a 100mm (4") x 25mm (1") strut (plank) on the underside of purlins adjacent to their ends.



3. Using two nails at each end install a 100mm (4") x 25mm (1") strut (plank) on the underside of the rafters adjacent to their both ends.

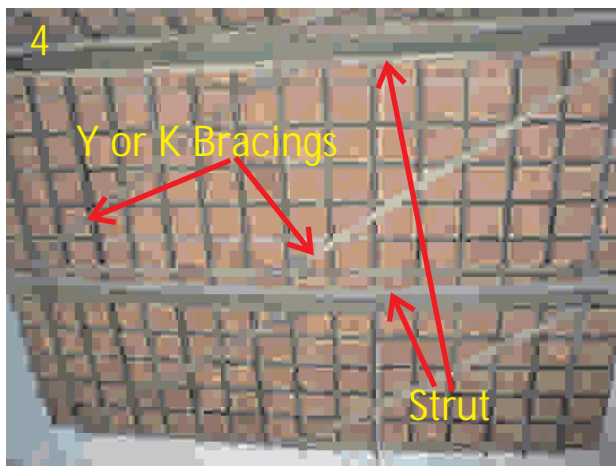

4. Install diagonal bracings starting from one end of a strut to the strut at the far end maintaining the angle close to 45 degrees, otherwise install more than one set of bracings.

Alternative cheaper & simpler option for bracings

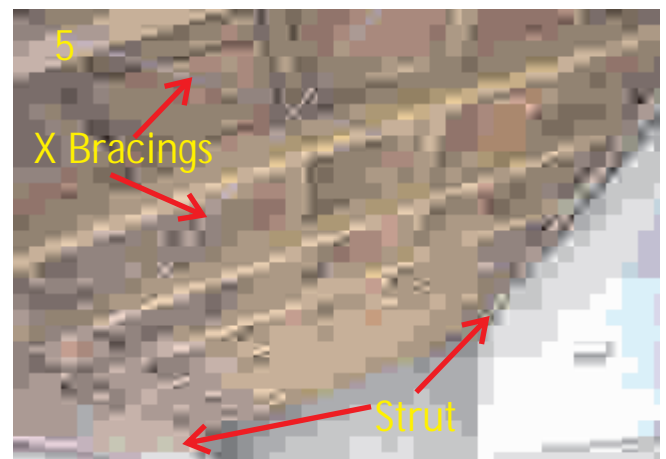

5. Use 3 to 5 strands of 13 gauge GI wires. Install them in "X" configuration only.

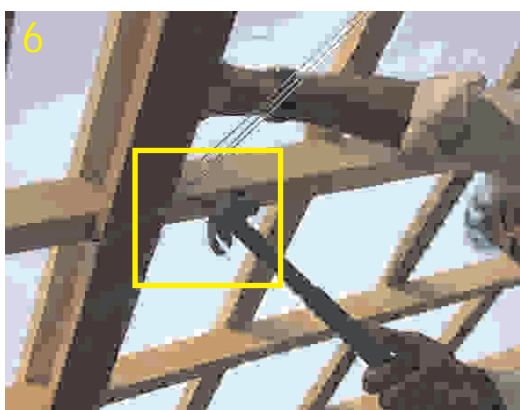

6. Tie one wire at a time around the joint of strut with rafter or purlin, stretched with carpenter's hammer.

7. Pre-tension wires by twisting all wires along one diagonal together with a piece of rebar.

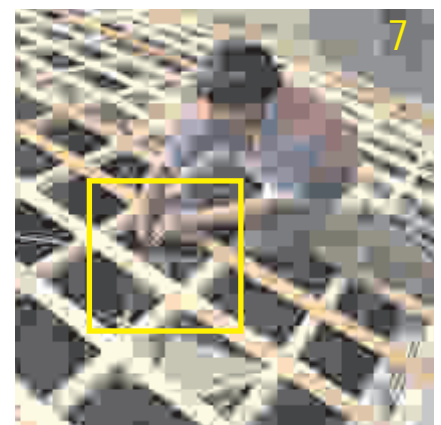

8. Anchor Pitched Roof Support Structure to Wall



Disaster Type: **E** **W**

Weakness : (a) Poor connection between roof framing and wall

Where to Install? : At the junction of (a) roof framing rafters and eave level walls, & roof purlins and gable walls, (b) roof projection at eave level and wall (in case of Cyclone hazard), (c) roof beams on gable wall.

How?

a. Anchoring Rafters & Purlins to Eave & Gable Walls

Anchor rafters or purlins with eave or gable band in the same way the floor joists are anchored to band



1. MS angle 35x35x3mm 75mm (3") long installed in eave or gable band for anchoring rafters and purlins.



2. 6mm MS bar installed in Eave level RC Band to anchor purlin or rafter by simply bending over them.



3. Pieces of 10 gauge GI wires attached to reinforcing bars in eave band leaving 300mm (12") long ends projecting out.

Alternatively, cheaper and simpler options...

4 & 5. Tie down rafters with two strands of GI wires.



b. Tying Down Roof Projection at Eave Level To Wall



For Wind speed Zone IV & V only **W**

Install a tie between eave level roof projection & wall below eave level at approximately 45 degrees to wall

- Made of 10mm TOR rod, or
 - MS angle 35x35x3mm, or
 - 25x100mm timber piece
- Connect tie securely at both ends using two or more nails or screws.

7

C. Anchor Ridge beam and Intermediate beams to gable wall

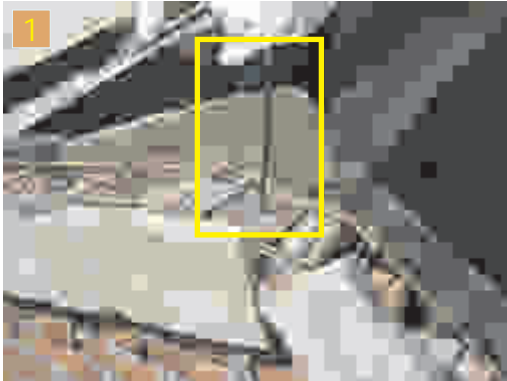

Install 12mm diameter bolt 250mm (10") long with a 100x100x5mm MS plate welded at its bottom in the band at the right location.

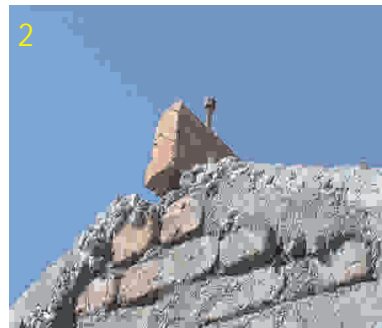

Once concrete becomes hard place timber beam with a through hole over the bolt and place a washer and a nut to anchor it down.

9. Secure Roofing to Roof Frame & Wall

Disaster Type: **E** **W**

Weakness in pitched roof: (a) Absence of anchoring of roofing tiles to framing, (b) Weak anchoring of sheeting to framing, (c) Weak anchoring of roofing to gable wall.

Where to Install? : At the (a) Connections between roof frame elements, namely purlins, rafters and beams, (b) Junction of roofing to roof framing and (c) Junction of roofing with gable wall.

How?

a. Connections between Roof Frame elements, namely purlins, rafters and beams



In wind speed area use galvanized metal straps along with 2 nails. Pre-drill pilot holes.

Alternately, cheaper and easier option is tying together of elements with multiple strands of 10 gauge GI wires.

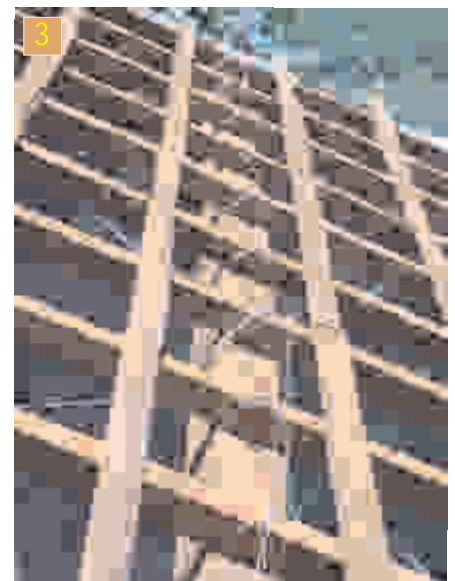

Connection of purlins & rafters, and beam & rafters.

b. Secure Roofing to Roof Frame

Anchoring Sheeting E W

Secure roof sheeting to purlins using 'J' hooks or 'U' Hooks.

Nut
30x30x6mm gauge MS washer
Sealing washer neoprene or bituminous felt
'J' hook

Nut
30x30x6mm gauge MS washer
Sealing washer neoprene or bituminous felt
'U' hook

Hooks must be installed with nut, 6 gauge MS washer followed by washer of Bituminous Felt or Neoprene.

Wind Speed Zone V only W

The holes in sheeting must be made in ridges to minimize water leakage.

Anchoring Roofing Tiles E W

1

2

GI Hook

Anchor each tile or every other tile to purlin with GI hooks.

3

Anchor wires or rod to eave-board

4

2-10 gauge wires to be taut

Anchor lowest row of tiles at eave level with 2- 10 gauge GI wires or 6mm MS rod from one end to the other.

7

Anchoring Roofing Tiles (cont.)

In wind speed zone



1

Install RC Strips 100X100mm in size with 10mm dia. TOR bar placed at spacing not exceeding 1200mm (4' 0").

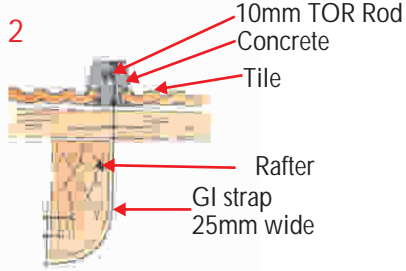

2

Anchor RC strips to rafters using GI straps.

Roofing to Gable Walls E W



1

On top of gable wall install RC load wall 230X100mm (9"x4") in size with 1-8mm TOR bar.



2

Connect the bar to 8mm TOR bar projecting out of the gable band and then fully encase it in concrete.

10. Secure RC Slab to Wall

Disaster Type: E W

Weakness Tackled: (a) Absence of connection between RC slab and walls on which it is resting

Where to Install? : At the junction of slab and wall.

How?

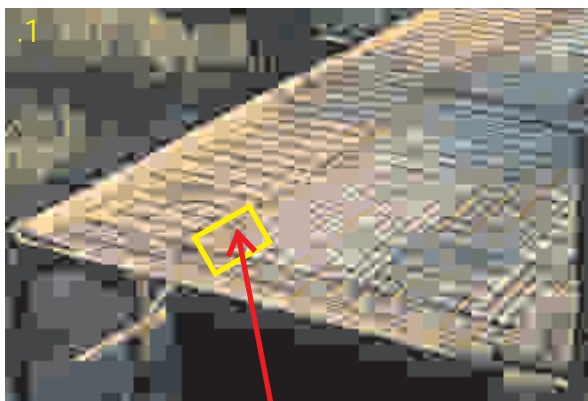

1

Connect all vertical rebars in the wall at corners and openings to rebars in slab by bending and making 450mm (18") overlap, and tie with binding wires.

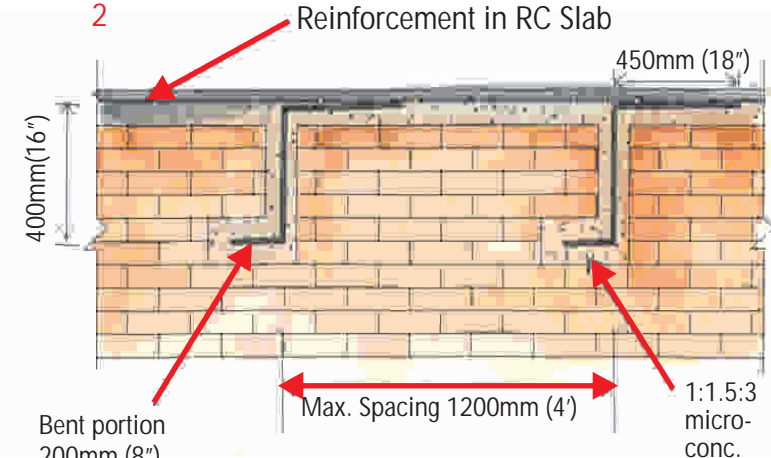

2

Special Anchor for Seismic & Wind Speed Zones V



11. Stiffening of Timber Beam to Column Connection

Disaster Type: **E**

Weakness : (a) Weak connection allows excessive side sway of timber frame that supports the roof or floor.

Where to Install? : (a) At the junction of timber column and timber beam.

How? Install knee braces from bottom of beam to face of column.

1

MS Angle Knee braces

Install at least two nails at each connection

Install one knee brace for each beam resting on column from different directions.

Knee brace connection must be able to take tension and compression.

Knee brace should be heavy enough to resist buckling under pressure.

2

Wooden Knee braces

12. Secure Doors & Windows

Disaster Type: **W**

Weakness : (a) Doors & windows anchoring to walls weak against suction; (b) Weakness of window glass against air pressure/suction

Where to Install? : (a) At junction of opening frames and walls; (b) Locking arrangement; (c) Glass pane in windows.

How?

1

Anchor door frame with at least 6 holdfasts, and window frame with at least 4 holdfasts.

2

Hold-fasts to be at least 230mm (9") long. It must be tied to vertical bar.

- Make smaller glass panes, or
- For low cost place plastic film on glass, or
- Install metal screen on the

3

Provide strong locking arrangement to resist wind suction.

4

7

13. Provide Damp Proof Course

Disaster Type: **F**

Weakness: Weakening of super-structure masonry through wetting from capillary action.

Where to Install? : At the junction of wall and plinth.

How?



1 & 2. Make RCC Band at plinth level with proper rodding to minimize percolation.



Alternatively, a cheaper option

3. Use sheet of polyethylene, or plastic or bitumen coated woven polypropylene sacks just at the base of wall.

14. Construct Flood Resistant Plinth & Superstructure

Disaster Type: **F**

Weakness Tackled: (a) Water inundation in house, (b) Weakening of mortar (mud or otherwise) by wetting and scouring.

Where to Install? : (a) Plinth level, (b) Inside and outside wall faces.

How?



1. Plinth height to be minimum 150mm (6") higher than the previous high water mark. Use cement mortar in construction.



2. Plaster with cement mortar on both sides of the walls.



3. Cement pointing on both faces fully or plastering of bottom 600 or 1000 mm with upper portion pointed, especially with mud mortar.

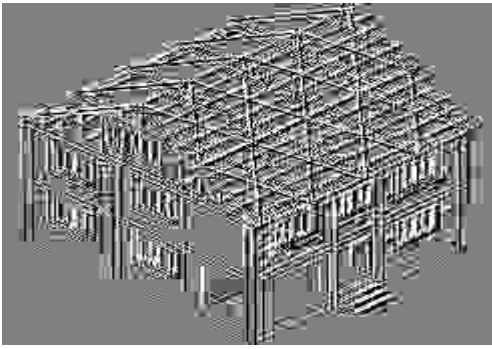

In the disaster prone areas of India different building systems are used. Many of these buildings have been found to be vulnerable during the past disasters.



Four examples are given here to provide guidance on what special disaster resisting features must be included in the construction in Kashmir Vallies, Kutchch, Uttarakhand and Marathwada. Details of all these features are given in Chapter 7.

Following are the typical examples of buildings in each of the four regions



1.Houses in Kashmir Valley

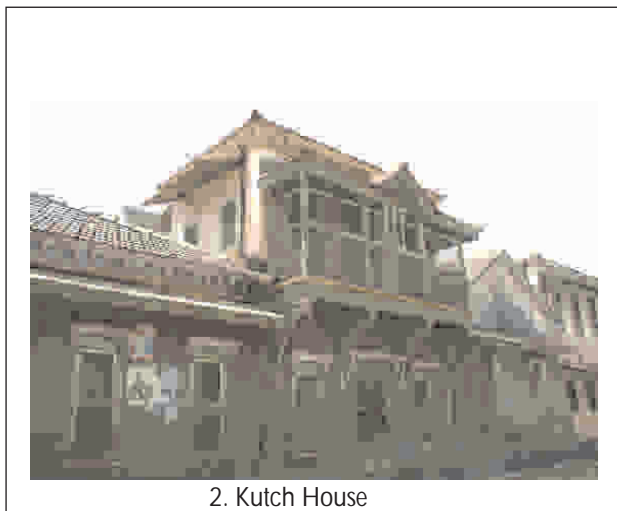

2. Kutch House



3.Uttarakhand House



4. Marathwada House

Disaster Resisting Features - Regional Variations



Typical Kutch Region House

Natural Hazard Risk Zones

Seismic Zone V
Wind Speed Zone IV (50 to 55 m/s)
Flood: Not Applicable

Typical Building Specifications

Wall : All walls including gables - Load bearing brick or stone masonry.
Floor : Intermediate floor - R. C. Slab.
Roof : Clay tiles or CGI sheeting on purlins supported on rafters spanning from ridge beam to eave walls with intermediate beams.

Disaster Resisting Features for New Construction

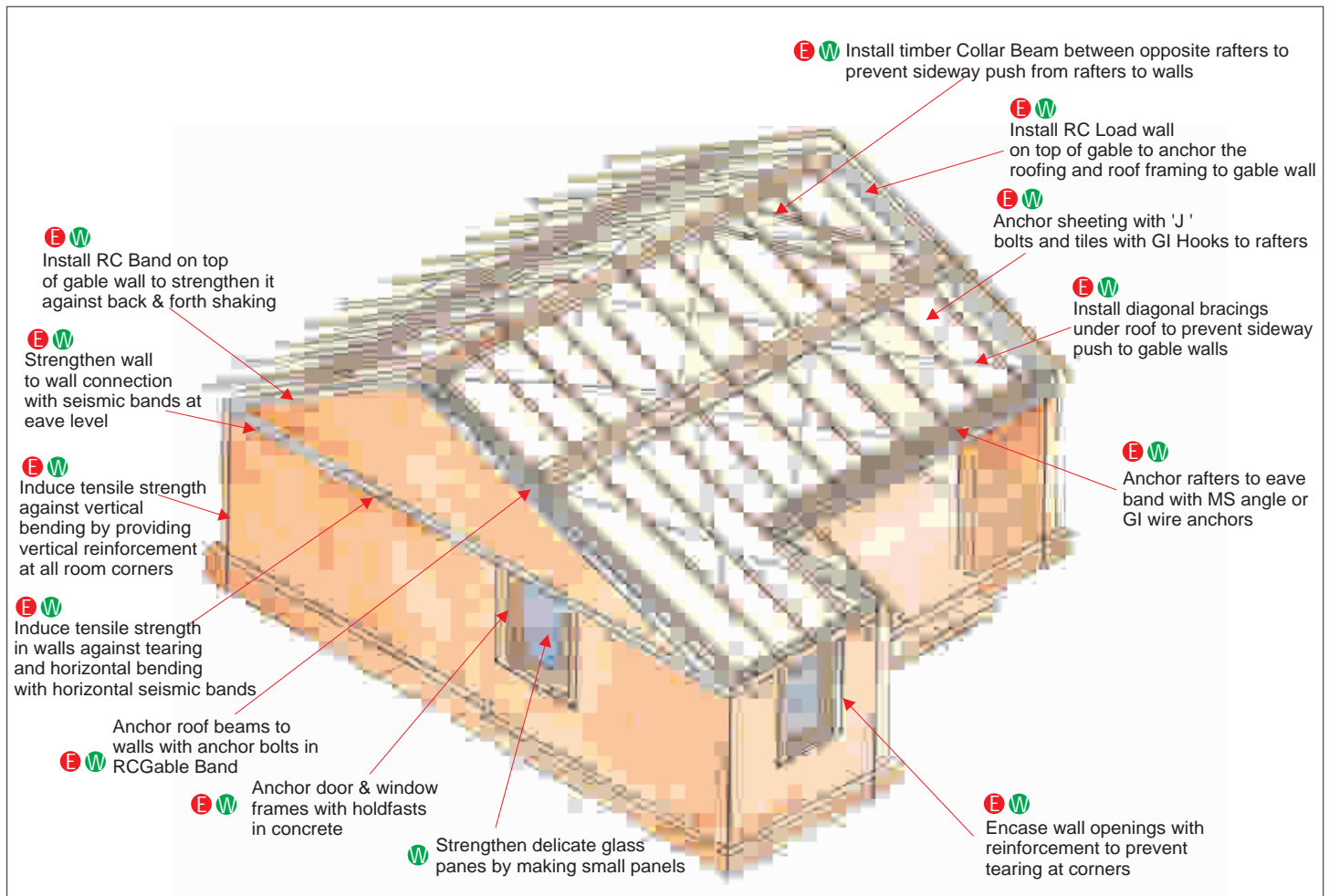

Follow all basic rules of masonry construction. Use 1:4 Cement:Sand mortar in walls. See Chapter 7 for all other information

E Earthquake

W Wind

F Flood & Rain

Typical Kashmir Region House

Natural Hazard Risk Zones

Seismic Zone V

Wind Speed Zone IV (50 to 55 m/s)

Flooding : Likely in valleys

Typical Building Specifications

Wall : Up to eave level - Load bearing brick & stone masonry.

Gable walls - Timber laced masonry or timber planks or CGI sheets.

Floor : Intermediate and Attic - Timber planks on timber joists.

Roof : CGI sheets on timber purlins supported on timber trusses.

Disaster Resisting Features for New Construction

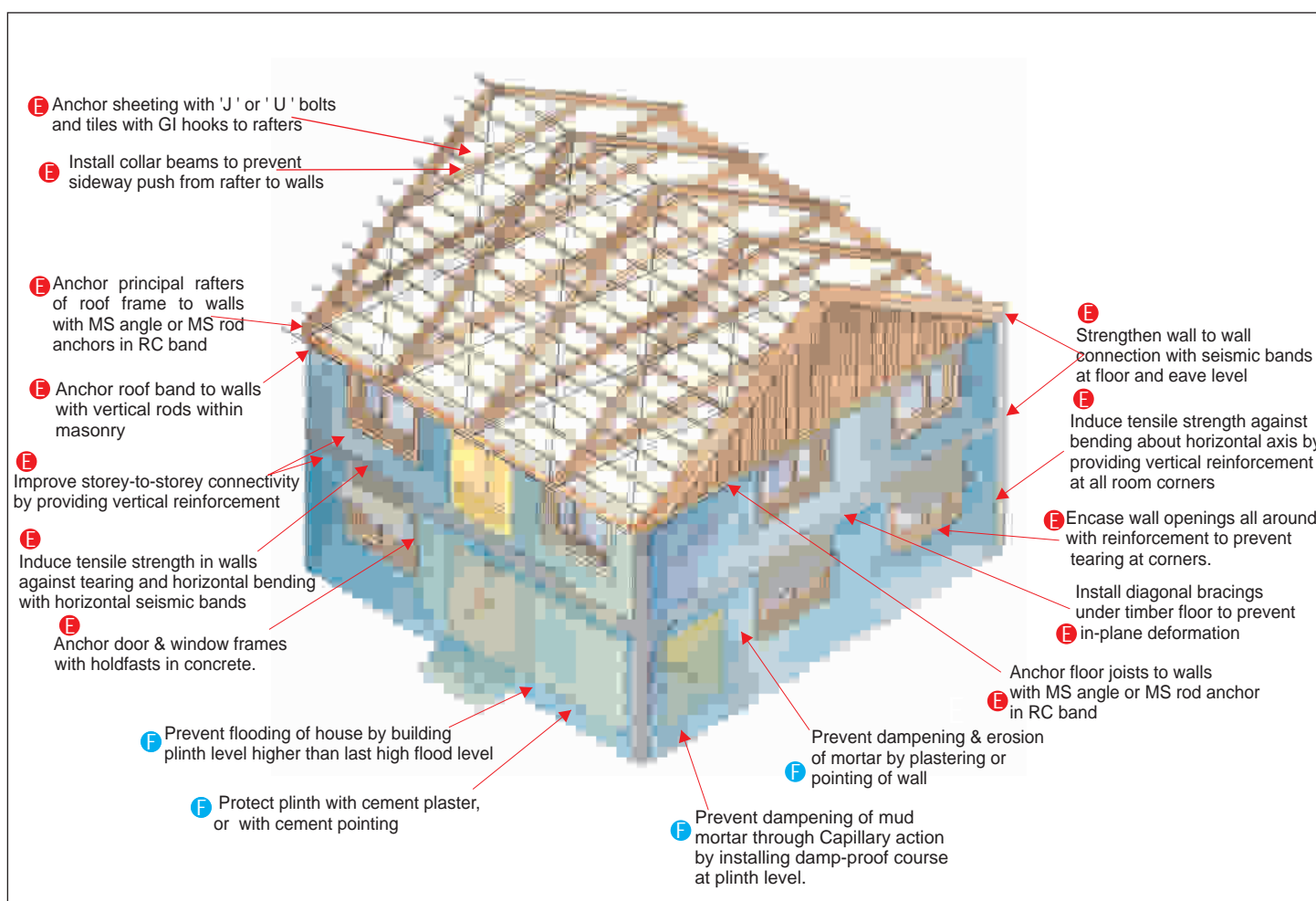

Follow all basic rules of masonry construction. Use 1:4 Cement:Sand mortar in walls. See Chapter 7 for all other information

E Earthquake

W Wind

F Flood & Rain

8

Typical Latur Region House

Natural Hazard Risk Zones

Seismic Zone III

Wind Speed Zone II (39 to 44 m/s)

Flood : Not Applicable

Typical Building Specifications

Wall : Non-load bearing - Stone masonry.

Roof : Mud on timber deck supported on columns with CGI sheet awnings.

Disaster Resisting Features for New Construction

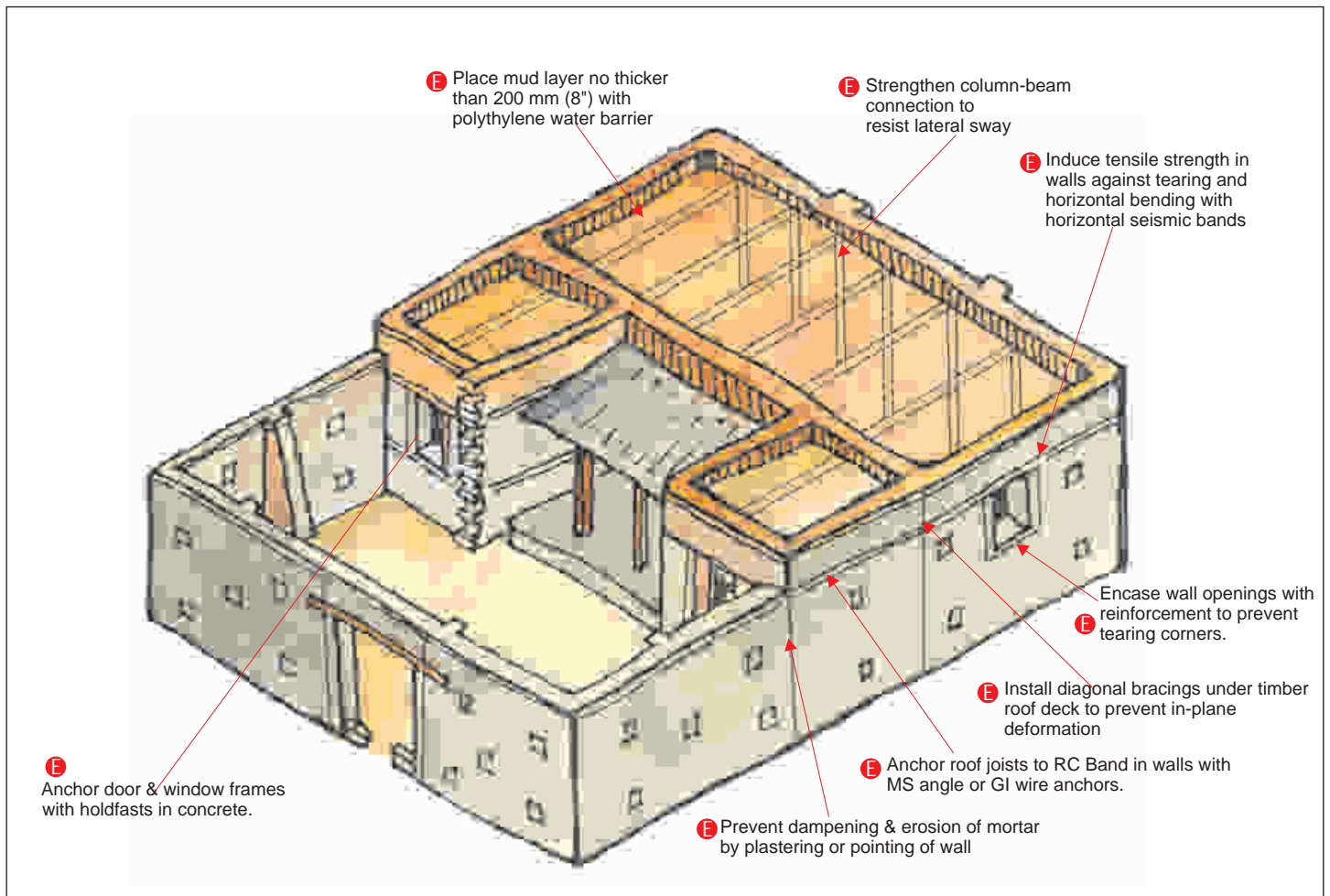

Follow all basic rules of masonry construction. Use 1:6 Cement:Sand mortar in walls. See Chapter 7 for all other information

E Earthquake

W Wind

F Flood & Rain

Typical Garhwal - Uttarakhand House

Natural Hazard Risk Zones

Seismic Zone V

Wind Speed Zone II (39 to 44 m/s)

Flood : Not Applicable

Typical Building Specifications

Wall : All walls including gable walls - Load bearing stone masonry.

Floor : Intermediate floor - Timber plank on timber joists.

Roof : Slate on planks supported on purlins spanning between gable and principle rafters.

Disaster Resisting Features for New Construction

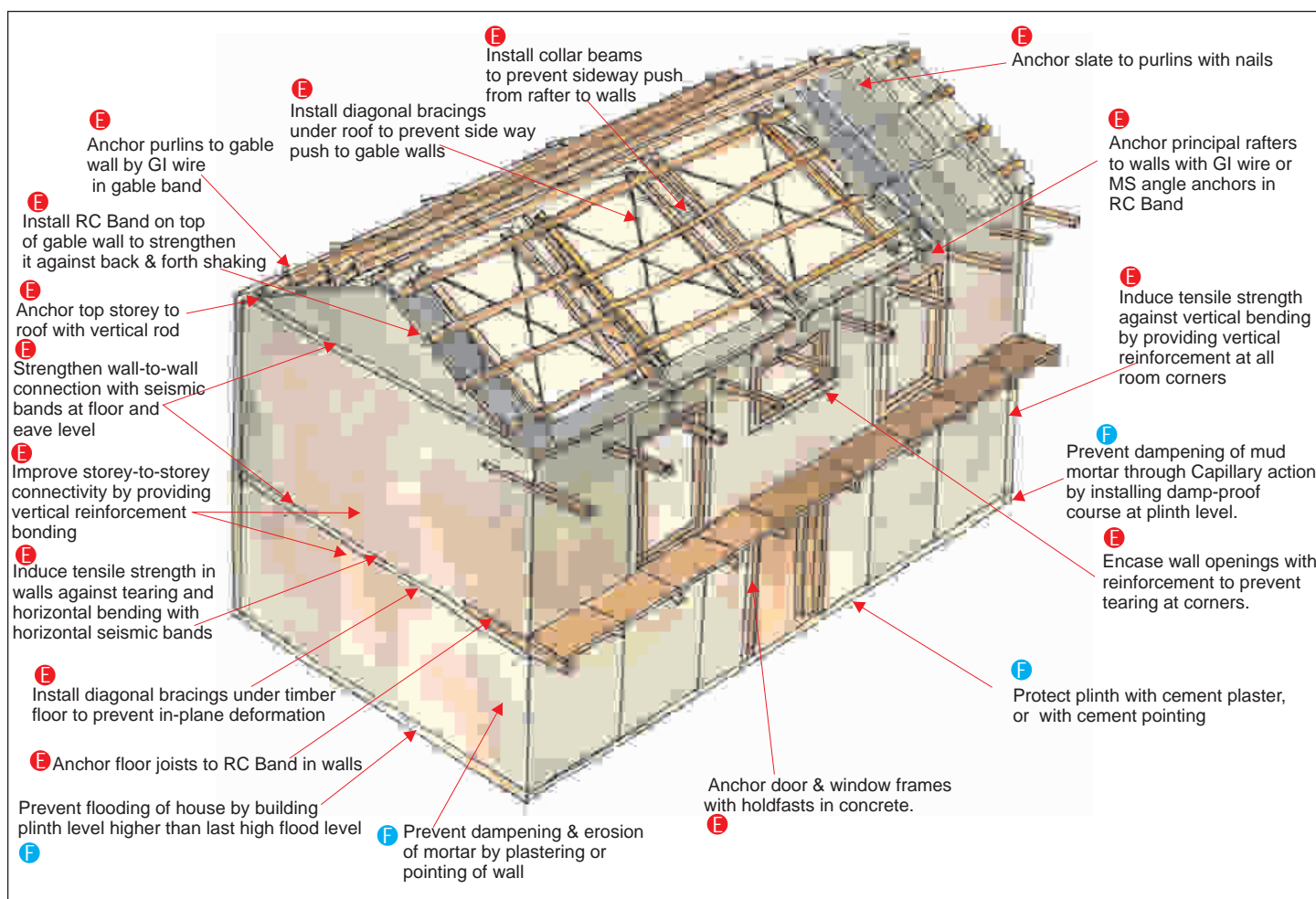

Follow all basic rules of masonry construction. Use 1:4 Cement:Sand mortar in walls. See Chapter 7 for all other information

E Earthquake

W Wind

F Flood & Rain

9

Material Quantities for Disaster Resisting Features

Now the reader has understood the disaster resisting features that should be used by him in his area. Next when he plans to use them in new construction, the main question that he will be faced with is “how much quantity of materials are needed” and “how much extra money he will have to spend”.

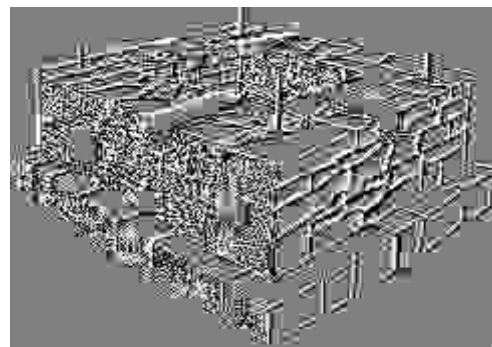

How to use the information on Material Quantities?:

- Here, for a specific measure of each feature, the quantity of materials required such as cement, steel bars, sand, aggregates etc. are given.
- The user has to finalize which features he is going to use and determine the quantity for each feature, e.g. The number of running meters of RC Band.
- Next, with that quantity in hand, use the information provided in this chapter.
- Simply multiply measurement of a particular feature to the material quantities given in this Chapter to arrive at the total quantity of materials required.
- To specify quantity in each case the most commonly used measuring systems are adopted to make it easy for user to arrive at the quantity and order the materials.

Material quantities are listed for applicable to one or more of the Seismic Zones III, IV and V, and Wind Zones III and IV. The items in which no specific Zones are specified are applicable in all Zones.

Item no. 1

Vertical Reinforcing Bar installed within masonry and encased in 1:1¹/₂:3 micro concrete with min. all around concrete cover of 50mm (2”).



Material quantities given below are required for 10 m (32' 9¹/₂") length of Vertical Bar

	Cement	0.002 Cu.m = 0.65 Bags		
	Sand	0.033 Cu.m = 0.012 Brass		
	Aggregates	0.065 Cu.m = 0.023 Brass		
		10mm TOR	12mm TOR	16mm TOR
Steel		6.17 kg.	8.89 kg.	15.80 kg.

Item no.2

Reinforced Concrete Band 250mm to 450 mm (10" to 18") wide and 75mm (3") thick with 1:2:4 concrete and 2 - TOR bars in longitudinal direction & 8mm dia. TOR cross-links @300mm(12") c/c.



Material quantities given below are required for 10m (32' 9¹/₂") length of RC Band

	230 thk. Wall		350 thk. Wall		450 thk. Wall	
	10mm TOR main reinf.	8mm TOR main reinf.	10mm TOR main reinf.	8mm TOR main reinf.	10mm TOR main reinf.	8mm TOR main reinf.
10mm TOR main	12.35 kg.	0	12.35 kg.	0	12.35 kg.	0
8mm TOR main	0	7.91 kg.	0	0	0	0
8mm TOR cross link	4.61 kg.	4.61 kg.	5.93 kg.	0	7.24 kg.	0
Cement	0.037 Cu.m = 1.11 Bags		0.056 Cu.m = 1.69 Bags		0.072 Cu.m = 2.17 Bags	
Sand	0.09 Cu.m = 0.032 Brass		0.12 Cu.m = 0.042 Brass		0.16 Cu.m = 0.057 Brass	
Aggregates	0.18 Cu.m = 0.064 Brass		0.25 Cu.m = 0.088 Brass		0.32Cu.m = 0.11 Brass	



Item no.3

Rafter and Purlin Anchors to Wall Band consisting of different options including MS Angle, MS Rod, and GI wires.

Material quantities given below are required for connections at 10 locations

Option 1	Option 2	Option 3
MS Angle 35x35x3mm 150mm(6") long	6mm bar - 600mm (24")Long	2- GI Wire 600mm(24") long
MS Angle with 2-14mm holes = 2.40 Kg	6 mm dia. Bar = 1.33 Kg	10 gauge GI Wire= 0.73 Kg
100mm Long(4") 12 mm dia. Bolt with 2 nos. washers & 1 nos. nut. = 20.00 Set	2nos. 10 gauge 75mm(3") long nails	2nos. 10 gauge 75mm(3") long nails
230mm Long(9") 8 mm dia. Bar welded to base = 0.91 Kg		

Item no.4
Ridge and Intermediate Beam Anchor to Wall
consisting of MS anchor bolt with bearing plate.



Material quantities given below are required for connection of <u>10 beams</u>
12mm dia. bolt 250mm(10") long with a 100 x 100 x 5mm(4"x4"x1/4") MS plate welded at its bottom = 20.00 Set



Item no. 5
Manglore Tile Anchors consisting of GI
wire clip.

Material quantities given below are required for <u>10 Manglore Tiles</u>
Manglore Tile Anchors: 3mm dia. Stiff GI Wire Hooks = 10 Nos.

Item no. 6
Manglore Tile Eave Level Anchor consisting of multiple
strands of 10 gauge GI wire.



Material quantities given below are required for 10m(32' 9 1/2") length of Roof
Eave Level Anchor: 2 - 10 gauge GI wire = 1.22 Kg



Item no. 7
Collar Beam for 1 Rafter pair consisting of timber plank.

Material quantities given below are required for 10 locations

12mm x 75mm(3") wood plank collar beam with 4 pre-drilled holes of 8mm diameter.	= 10 Nos.
1 -8mm diameter bolt with 2 washers & 1nut.	= 40.00 Set

Item no. 8
Diagonal Bracing of "K" configuration & Struts made of timber planks to be installed under Floor and Roof Framing.



Material quantities given below are required for 10 Sq.m(100Sq.ft.) of the Floor / Roof area

100mm (4") x 25mm (1") strut (timber plank)	= 0.124 Cmt.
4 nails / plank -10gauge 100mm(4") long	= 0.215 kg.

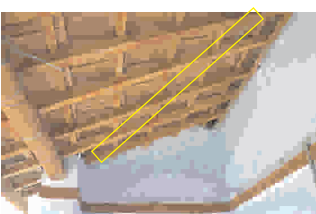

Item no. 9
Diagonal Bracing of "X" configuration & Struts under Roof Framing with Struts made of timber planks and bracings made of 4 strands of twisted 13gauge GI wires.

Material quantities given below are required for 10 Sq.m(100Sq.ft.) of the Roof area

100mm (4") x 25mm (1") planks	= 0.016 Cmt.
10gauge Nails100mm(4") long	= 0.143 kg.
13 gauge GI Wire	= 1.04 kg.

10

Don'ts - New Construction

Care must be taken to follow every rule given in this book in all construction. But in disaster prone areas extra care is needed. The construction photographs shown here are from the Earthquake and Wind Speed Zone V. These are not isolated examples. They represent general scenario in disaster prone areas of India.

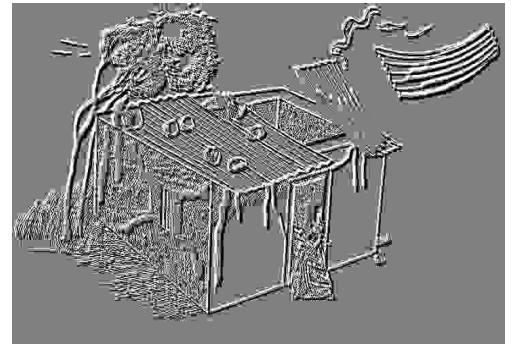

Most Commonly Committed Mistakes



Never construct stone masonry by simply stacking one stone over another without proper fitting and using mortar.



Never leave vertical joints unfilled without mortar.

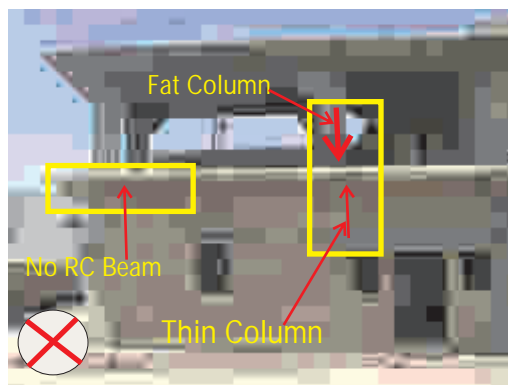

1. **Never** provide RC columns without providing RC beams.
2. **Never** construct fat RC column on top of thin RC column or on top of masonry.
3. **Never** construct one column on another with their centre lines not matching.

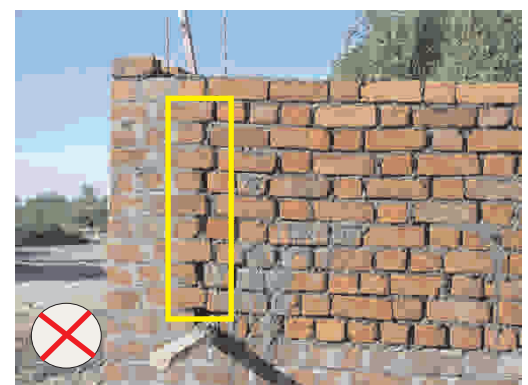

Never connect one wall to another through the use of tothing left out in the wall that is built first.

**Never make any one of these mistake.
In a disaster this could be an expensive mistake
and could put your life at risk**

Common Mistakes In RC Work

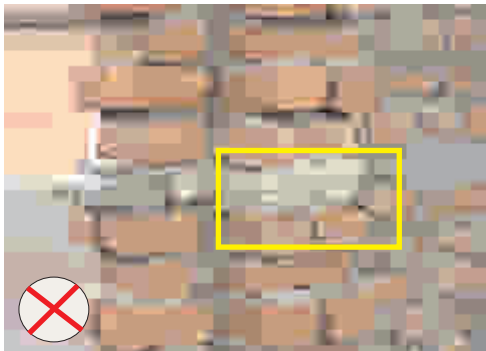

Never place reinforcing bars without or with little concrete cover. They add very little to the strength.

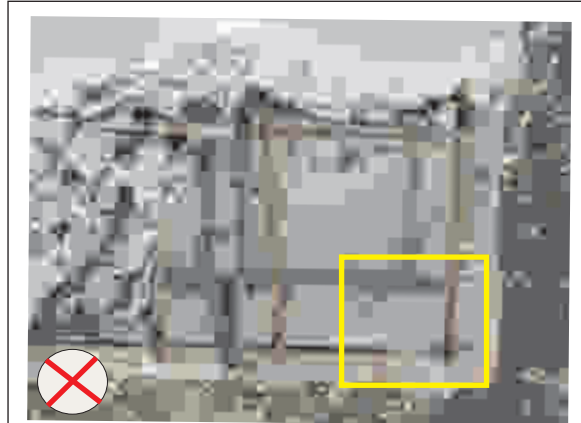

Never leave free end of reinforcement in a RC Band without overlapping with other bar.

Never construct RC Band that is much smaller than the width of wall.

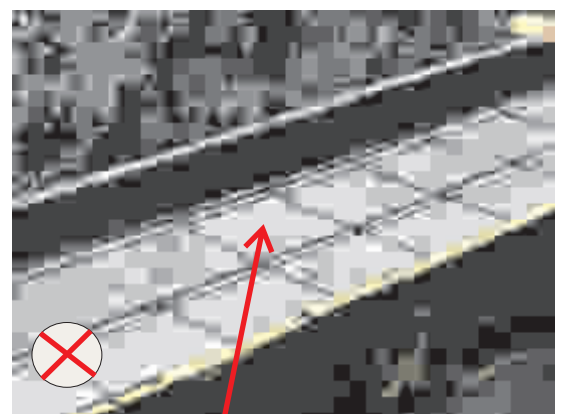

Never finish the surface smooth on which concrete is going to be placed, rather make it rough.

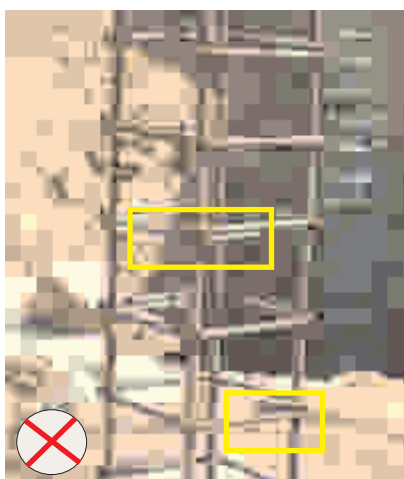

Never use rings without hooks bent inwards at 135°.



Never do concreting without proper and continuous rodding, or use vibrator

NEVER ALLOW CONCRETE TO DRY UNTIL AFTER CURING ENDS



Never connect one bar to another with hooks.

10

Common Mistakes in Masonry

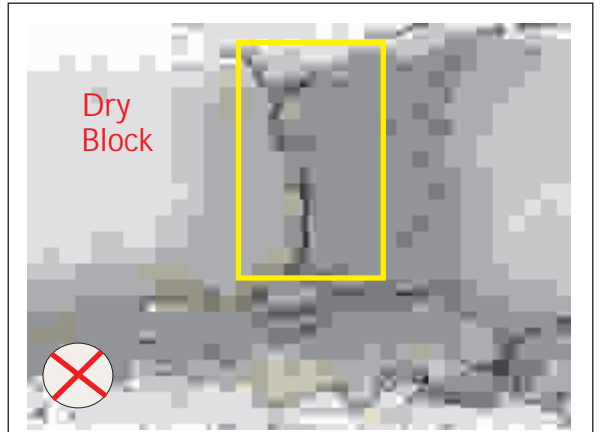

Never use Concrete Blocks in dry state in construction . It will suck the water from mortar and a crack will develop.

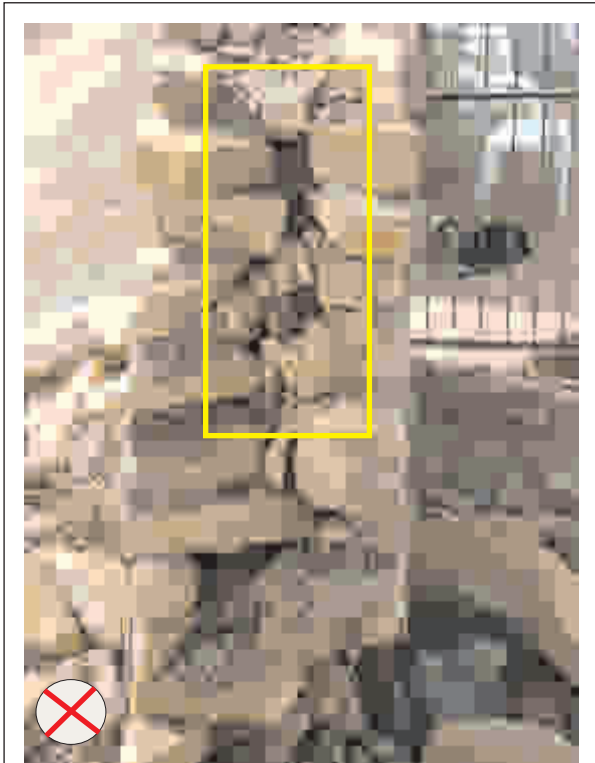

Never place stones without interlocking where both faces of wall remain separate.



Never use thin concrete blocks in vertical position. They will make unstable wall.



Never build RC slab without full connection with the beam.



Never make two walls that are not connected properly to each other.

Never make inner wall without RC Band that is integrally connected to the Band in outer walls.

Never use different materials in the adjacent walls.

Common Mistakes in Masonry (Cont.)



Never construct a single free standing wall taller than 1.5m (5'-0").



Never rest roof on unreinforced brick piers.



Never construct outside walls without constructing interior walls at the same time and fully connected to them.



Never construct RCC columns without constructing beams resting on it and fully connected to it.



Never construct corners alone without rest of the walls.

11

Restoration Procedures

Restoration

1st Step to Rehabilitation

Bringing back a damaged structure to its pre-earthquake state is called Restoration. This results into the restoration of its original strength. Painting, plastering or changing floor tiles is not restoration.

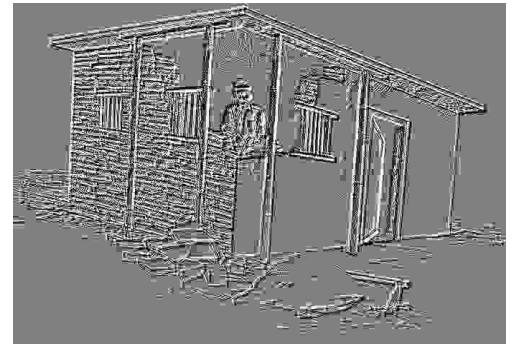

Damage Grading and Description Damage is categorized from G1 to G5

Grades as per IS:1893 (Part I)Page 33

Grade G-1:
Slight damage

Thin hairline cracks in plaster or in unplastered masonry that are not deep, and falling of some plaster.



Damage Measurement:
Only length of the cracks can be measured.

Effect on Structure:
This does not weaken the structure.

Grade G-2:
Moderate damage

Small cracks max. 5mm (1/5") wide in walls, falling of plaster over large areas, cracking of non-load bearing parts like chimneys, parapets, etc.



Damage Measurement:
Cracks are some times across the full thickness of wall. Length and width can be measured.

Effect on Structure:
The load carrying capacity of the structure is not reduced appreciably.

Grade G-3:
Heavy damage

Large and deep cracks 6mm to 10mm (1/4" to 1/2") wide in walls, widespread cracking of walls and columns, And tilting or collapse of chimneys.



Damage Measurement: Cracks are generally across full thickness of wall. Length, width and depth, all three could be measured.

Effect on Structure:
The load carrying capacity of the structure is appreciably reduced.

Grade G-4: Destruction damage

Gaps in walls, portions of walls about to collapse due to tilting, bulging, delamination or major cracks, or already collapsed.



Damage Measurement:
The height, width and depth of the collapsed portion or portions about to collapse are measured.

Effect to Structure:
Corner collapse,
Building is unsafe and can collapse further.

Grade G-5: Total collapse

A large part of the building, or all of it is collapsed.



11

Restoration Procedure for Wall Damage



Damage: Grade G-1 crack
Plaster cracking

Restoration Procedure: Replaster damaged portion



1 Make a 'V' notch along the crack



2 Clean it with wire brush, wash and wet with water.



3 Fill up the gap with 1:3 Cement mortar. Finish the restored parts to match the surrounding wall.



Damage : Grade G-2 type crack
Width up to 5mm (1/5")

Damage: Grade G-3 crack
Width more than 5mm (1/5")
but less than 10mm (1 / 2 ")



Restoration Procedure: Crack Sealing & Grouting:



1. Make a 'V' notch along the crack, or widen it with raking tool and clean it with wire brush.



2. Fix grouting nipples in the 'V' groove at a spacing of 150mm to 200mm, or leave holes at that spacing while sealing the crack with 1:3 cement mortar.



3. Prepare cement slurry 1:1 (non-shrink cement : water)



4. Fill up hydraulic pump or a simple hand-pump with non-shrink cement slurry.

5. Inject cement slurry into the nipple, or holes starting with the lowest nipple. Cut off the nipples, seal the holes with 1:3 cement mortar.



Restoration Procedure: Crack Sealing & Grouting: (cont.)

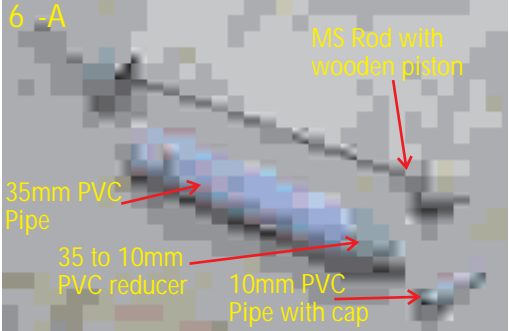

6 - A

MS Rod with wooden piston

35mm PVC Pipe

35 to 10mm PVC reducer

10mm PVC Pipe with cap

6. Simple hand-pump can be made quickly from PVC pipe pieces of 35mm and 10mm dia., a reducer, and a simple wooden piston.

Alternatively,



When a crack is large and more quantity of grout is to be pumped then a drum with a nozzle at bottom can be used.



6 - B

Fill up cement slurry and raise the drum and allow the slurry to flow under gravity pressure in the crack.

Alternatively, if non-shrink grout or grouting equipment is not available, then..

Restoration Procedure: Crack Sealing & Splicing:



1. Remove plaster, if existing and rake joints up to 12mm depth.

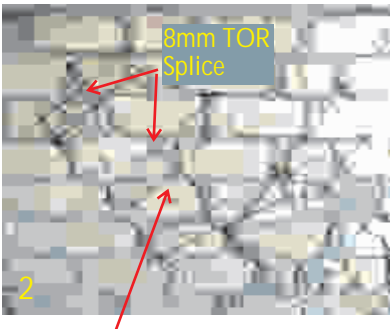

2. Fill the crack with 1:3 cement mortar (cement : fine sand) and install 8mm TOR splice on both faces of the wall.



3. Alternatively install 150mm wide 14 ga. 25x 25mm GI WWM with 100mm long wire nails inserted at spacing of max. 150mm.

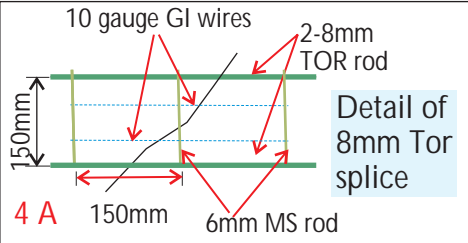

4 A

10 gauge GI wires

2-8mm TOR rod

150mm

6mm MS rod

Detail of 8mm Tor splice



5 A

Plastered WWM Splice

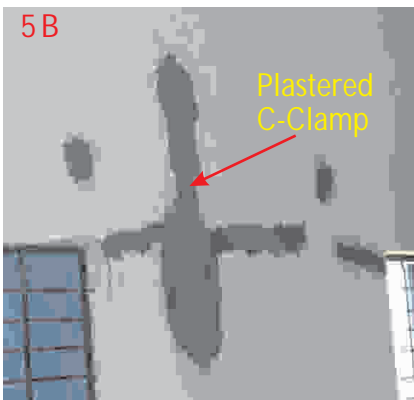

5 B

Plastered C-Clamp

4. If WWM is not available either use "C" clamp or use splice made of 2-8mm TOR rod.

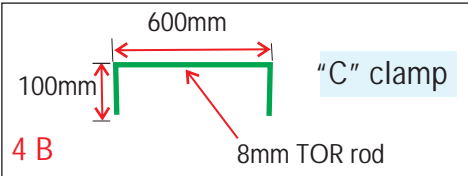

4 B

600mm

100mm

"C" clamp

8mm TOR rod

5. Plaster over the splice, C clamp or WWM with two 12mm coats of 1:3 cement plaster.

6. Cure it for 15 days.

11

Damage: Grade G-4
 Damage - Wall is in imminent danger of collapse or has already collapsed

The photographs below cover a variety of situations with G-4 Damage.

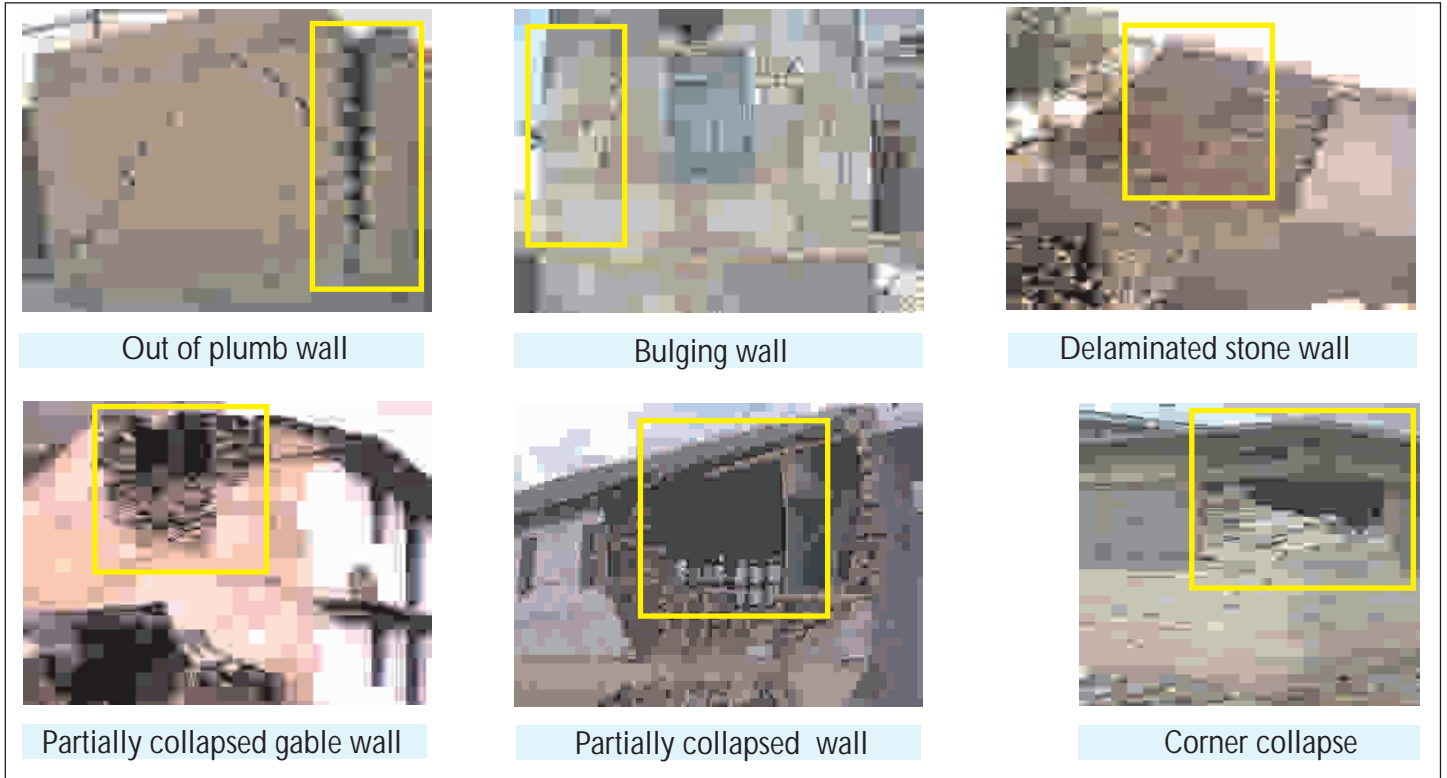

Restoration: Making the wall stable

In all of the above situations follow the procedure described
 Procedure: Rebuild entire wall or only the damaged portion of wall.

1. Mark the damaged portion of the wall plus 300mm (1'-0") extra on all sides.

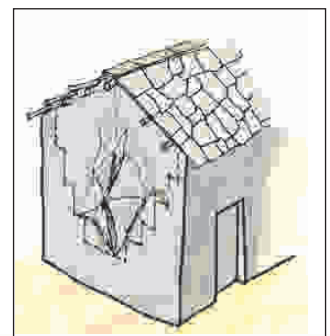

2. Support the roof or the floor above; remove the marked portion in stepped manner.

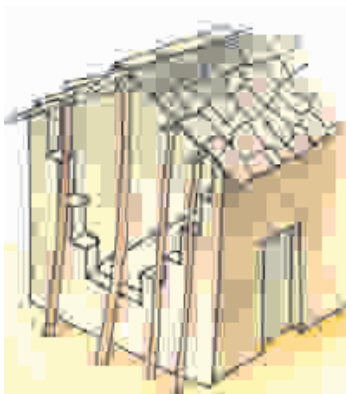

3. Rebuild the wall with the salvaged or new material. Use mortar that is stronger than that used in the existing construction.

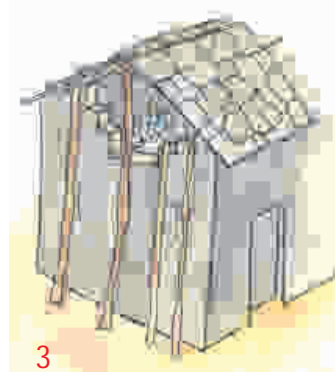

4. Once curing is over remove the props and finish the wall to match.

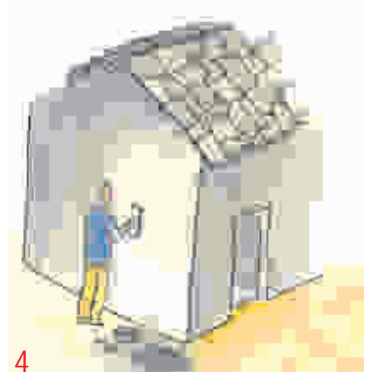

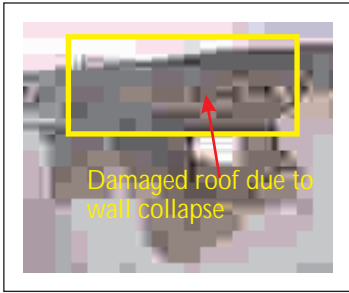

Restoration Procedures for Roof Damage

1. Restoration of Damaged Roof with CGI /AC Sheet or Clay Tile

A. Damaged timber elements

1. Remove all the roofing from damaged area.
2. If roof damage is because of wall damage then clear the severely damaged portions of walls and reconstruct them.
3. Repair the cracks and other minor damage.

4

4. Repair the cracked elements of timber by nailing or splicing with metal straps or MS flats. Pre-drill holes in old timber.

5

5. Replace the severely damaged timber elements of roof.

6

6. Replace CGI / AC sheets or tiles that were removed.

B. Deformed CGI sheets

Straighten out bent sheets remove any rusted edges around the existing nail / bolt holes with a file or a hammer.

Straighten out bent sheets using wooden hammer and 40mm dia. pipe under the sheeting.

Seal all open holes with M-seal.

2. Restoration of damaged RCC slab

A. Sealing of fine crack in RC roof

1. Clean the crack with wire brush.,
2. Fill it with cement : water (1:1) slurry and cure for at least 15 days, OR use polymer epoxy for grouting.

B. Sealing of Moderate (G2) Non Structural crack

1. Rake the crack with chisel.
2. Clean it with wire brush.
3. Seal it thoroughly with a sealant like M-seal using thumb pressure.

11

C. Restoration of Partially Collapsed RC Roof



1. Support the undamaged portion of the slab. Mark 600mm (2'-0") extra on all sides from the damaged portion.

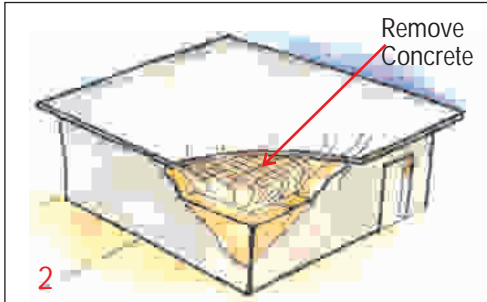
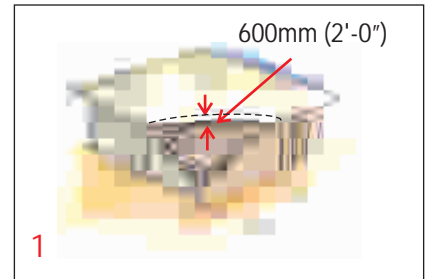

2. Break off concrete from the collapsed portion and straighten out the bars to get them in correct alignment. Rebuild damaged walls.

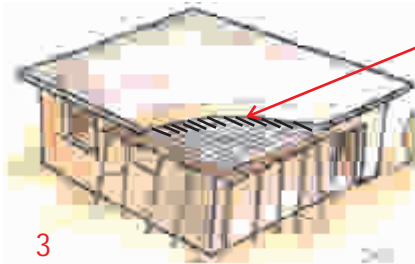

3. Install shuttering. Tie 750mm (2'-6") long steel dowel of the same diameter overlapping on each rebar.

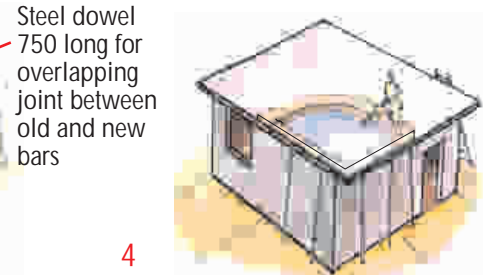

4. Apply bonding agent at the exposed edge of the undamaged slab. Pour concrete and cure the new slab for 15 days.

D. Saving a RC slab by restoration of severely damaged or collapsed walls supporting it

The damaged walls have to be restored carefully in a systematic manner so that roof does not get damaged.

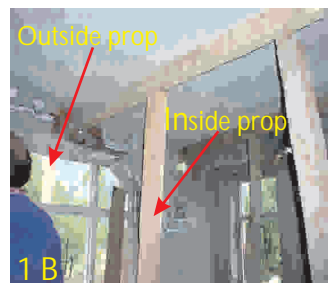
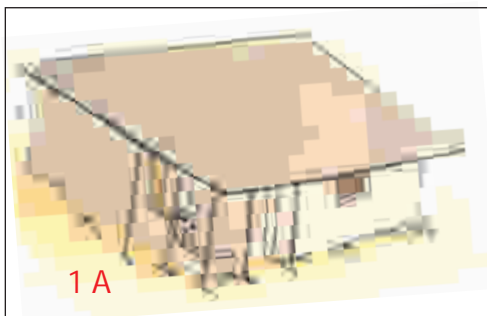

1. Prop up the slab inside and outside the building exercising care not to raise the slab. Start construction of the new wall from the corner. Build it in a stepped manner.

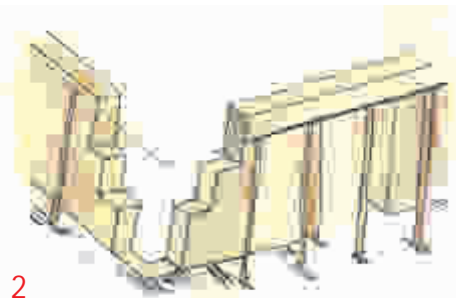

2. Wherever removal of damaged wall is required, it must not exceed 3m (3' 0") at a time. Continue the process till all damaged walls have been restored.

When restoration is complete, remove all the supports, and retrofit the entire structure as deemed necessary following the instructions for retrofitting

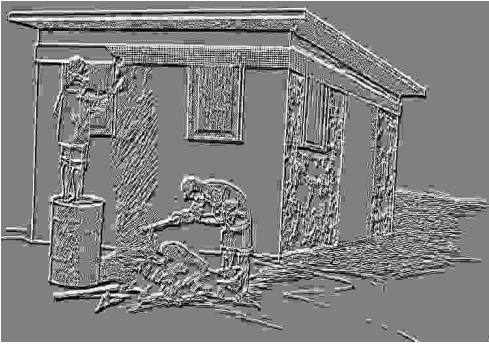

Preparing for Natural hazards like Earthquake, Cyclone and Floods:

It is neither possible nor economically viable to demolish all existing vulnerable structures in disaster prone areas. It would be best to upgrade their strength (i.e. retrofit them) to save them from damage and destruction in future.

WHAT IS RETROFITTING?

- It is possible to reduce the vulnerability of an existing unsafe building. There are simple ways to do this. It is called Retrofitting.
- Retrofitting means preparing a structure in a scientific manner to withstand the forces of a natural hazard that may occur in future. This needs to be done on all structures that are found to be vulnerable, whether they are damaged or not.
- It is generally the most economical and fastest way to achieve the safety of the people who occupy the vulnerable building.



Uttarakhand House



Kutchch House



Kashmir House

All these houses and thousands more in all disaster prone areas of the country are vulnerable to future disasters. They all cannot be demolished and rebuilt. So for the safety of their occupants they need to be retrofitted.

Advantage of Retrofitting

The advantages of retrofitting over replacing an existing building for safety against future disasters are:

- Retrofitting can be done in phased manner depending upon the availability of funds and time. So it is not necessary to retrofit the whole structure in one go.
- Retrofitting eliminates the need for a temporary shelter since retrofitting can be taken up in a few rooms at a time.
- Retrofitting eliminates the cost of total demolition and removal of debris from demolition.
- Retrofitting can save most of the improvements carried out in the building. There is no need to redo all of it.

12

RETROFITTING MEASURES FOR VULNERABLE EXISTING BUILDINGS IN DISASTER PRONE AREAS

If a building is not designed and constructed to resist the forces of expected natural hazards, it must be strengthened by introducing Retrofitting Measures as shown below to eliminate all the weaknesses present in the building as shown in Chapter 4.

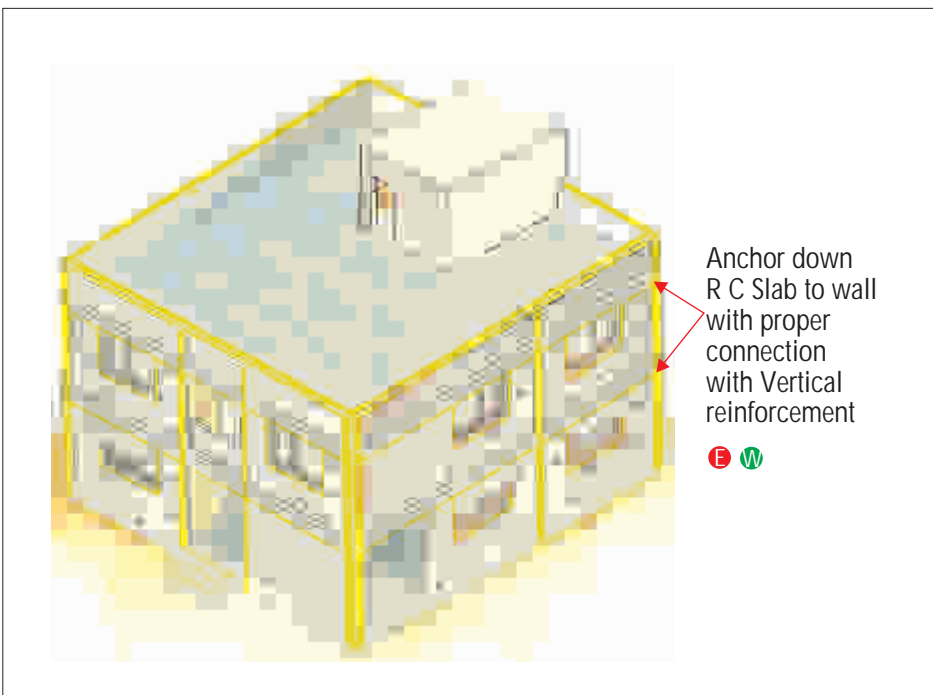
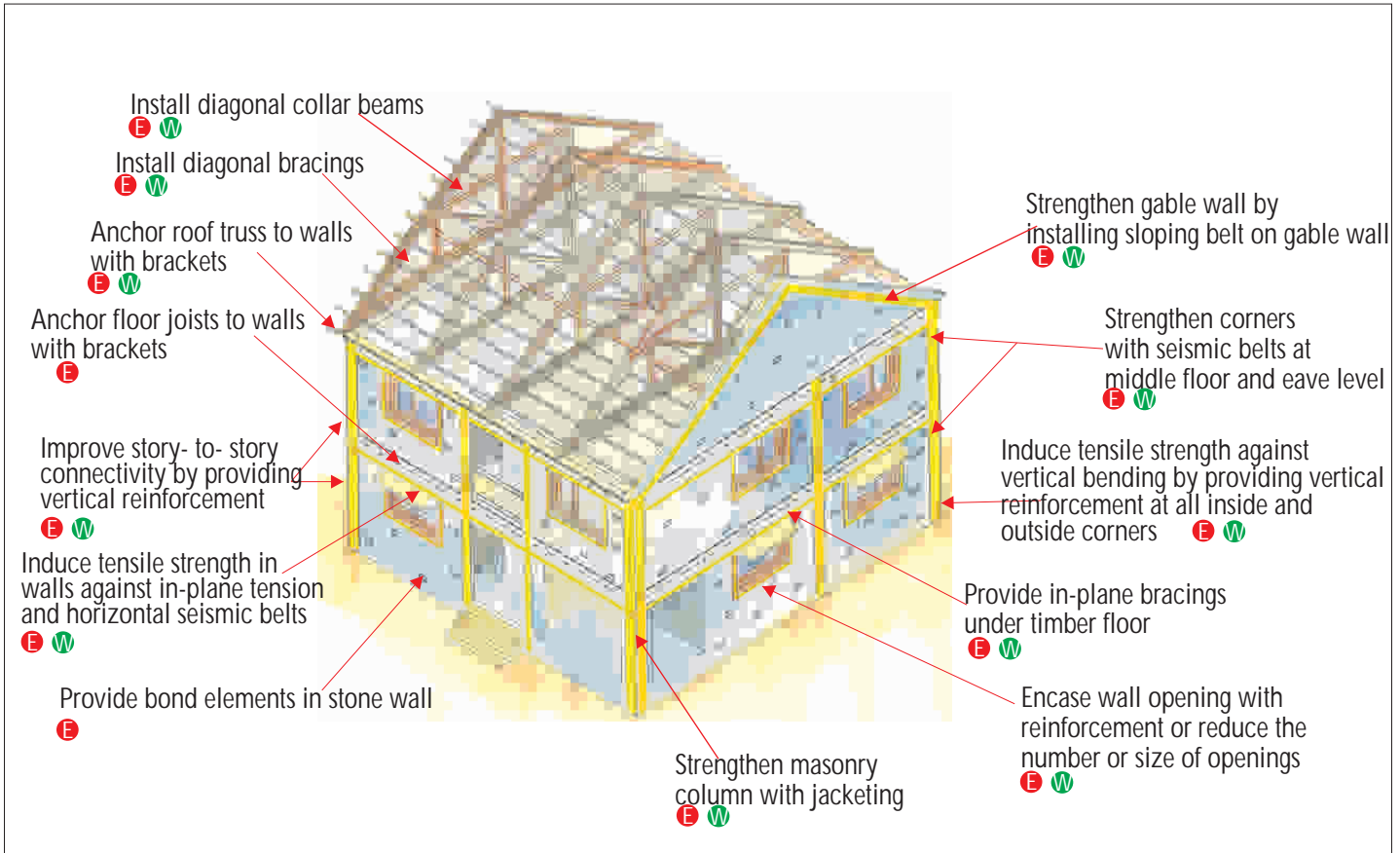

Remember:
Any vulnerable part of a building will benefit from the retrofitting measure only if the measure is securely bonded to that part of the building where it is applied.

Retrofitting of Existing Stone Masonry Walls

1. Cast In-situ RC Bond Elements in RR walls

Disaster Type: **E** **W**

12



Weakness in Random Rubble Wall:

Bulging and Delamination of wythes (faces) in RR walls because of

- Poor interlocking between two wythes.
- Absence of bond elements or 'through' stones.

Where to apply remedy? All parts of RR walls.

Specifications:

- Install one 'through stone' at horizontal and vertical distance of about 1m apart, with 500mm horizontal stagger.
- Use 8mm TOR rod 50mm shorter than the wall thickness, hooked on both ends.

Special equipment:

For stone extraction: A 12mm dia. MS rod no longer than 750mm long (2' - 6") with one end flattened and the other end pointed.

How to install RC Bond Elements?



1. Mark points at desired locations, avoiding built in cupboards. Remove surface plaster of 230mm x 230mm (9"x9") patch at each point.



2. Select a stone to be removed. Rake out mortar from all around using Extraction Rod. Loosen it gently and pull it out carefully.



3. Remove the material from behind the stone and make a 75mm (3") diameter hole till the stone on the other face is reached. Remove this slowly from other side.

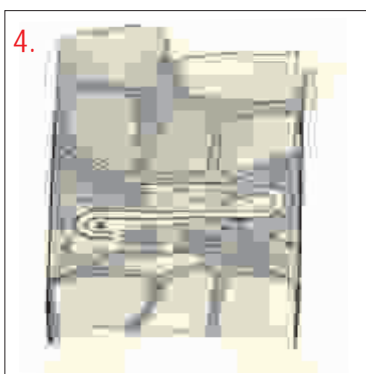

4. The hole should be dumbbell shaped, bigger in size at both faces and narrower in the wall core.



5. Fill the bottom half of hole with non shrink cement concrete, place rebar hooked at both ends and fill it completely with concrete.



6. Finish the surface with cement plaster. Cure for minimum 10 days.

Caution: Make no more than 6 holes at a time in a single wall, and fill them up with concrete on the same day. Exercise extreme caution not to damage the building by hammering while making holes. Do not use crowbar for this.

12

Retrofitting of Existing Stone Masonry Walls (cont.)

2. Horizontal Belt

Disaster Type: **E** **W**

Weaknesses in Brick, Stone or concrete block masonry walls:

Cracking caused because of:

- Poor wall- to- wall connection,
- Inadequate in-plane tensile strength (against tearing),

Where to apply remedy? Un-interrupted seismic belts are to be provided on all walls as shown here.

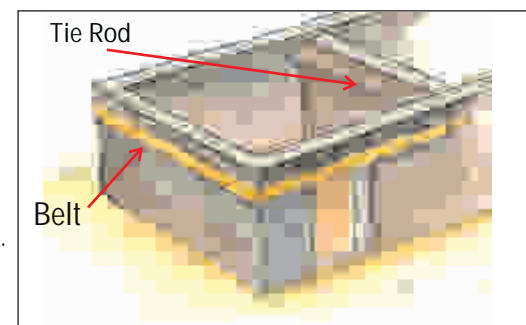

Just below the sloping top edge of gable walls.

Just below eave level when the roof is other than RCC slab

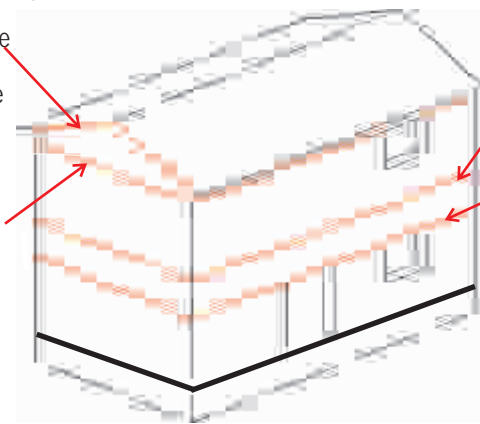

Just below floor level if floor is other than RCC slab.

At lintel level unless the gap between eave level and lintel is less than 900mm.

Tie Rod: When it is possible to install belt on only three walls then adjacent to the fourth wall a tie rod must be installed to ensure some continuity

Specification of Belt:

- Belt is made with reinforcement consisting of galvanized weld wire mesh (WWM) and TOR / MS bars.
- Reinforcement should be anchored to wall and fully encased in cement plaster or micro concrete from all sides.
- **Width** of belt shall be 30mm wider than the width of WWM.
- 13 gauge WWM is recommended since 10 gauge is too stiff to handle.

Specification of Reinforcement: For rooms with wall length 5m or less

Hazard Risk	Galvanized Welded Wire Mesh plus Galvanized MS Rods
Seismic Zone IV & Wind Speed Zone III	G13- 175mm wide with 8 longitudinal wires plus 2- 6mm dia. bars
Seismic Zone V & Wind Speed Zone IV	G13- 225mm wide with 10 longitudinal wires plus 2- 6mm dia. bars

The transverse wires in the mesh could be spaced up to 150mm.

Tie rod: It shall be 12mm dia. MS bar with each end threaded over an adequate length along with two nuts and a 100mmX100mmX5mm MS bearing plate.



These are used to anchor the belt to wall.



Shear Connector:

L-shaped bar in a RC Bond Element with its bent leg sticking out of the wall to which any reinforcement mesh can be attached.

- Weld Wire Mesh
- 8 mm TOR Rod leg for anchoring

12

How to install WWM Belt?



1

1. Mark the top & bottom edges of belt on wall using string and tube level.



2

2. Using electric grinder, or chisel, cut the plaster along the markings.



3

3. Remove the plaster from the marked area exposing wall surface.



4

4. Rake all the mortar joints to the depth of 15mm (5/8") using electric grinder.



5

5. In case of no electricity, use chisel. Clean the surface with wire brush and water.



6

6. Cut weld wire mesh as required.



7

7. Attach pre-cut 6mm reinforcing bars with binding wires.

8. Install WWM on the prepared surface.



8

Install Shear Connectors



9

9. In brick or concrete block wall use 100mm (4") to 150mm (6") long wire nails driven in to mortar joints, at 300mm (12") spacing in a staggered fashion in two rows.



10

10. In case of rubble walls install Cast in-Situ RC shear connectors with bar sticking out every 1.25m (4'0"). Attach WWM to the bar with binding wire. In addition use 100mm long square headed nails at 150-300mm spacing.



11

11. Provide spacers 15mm (1/2") thick between the wall and the mesh.

12

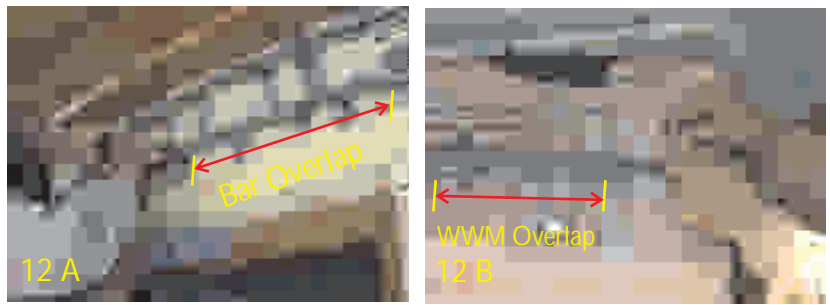

12. Ensure continuity of reinforcing bars as well as of WWM through lap joints minimum 300mm (12") long.



13. Splash the exposed wall surface with water and apply neat cement slurry followed by first coat of cement : sand (1:3) plaster.

14.A Tie rod must be installed level from one wall to the opposite wall going clear through a conduit placed in both walls and through the belts.



- All tie-rods must be in place, before plastering the belt.
- Tie-rods must be level
- Tie rods must have approximately 2.5m (8' 2") vertical clearance from the floor. In the absence of such clearance install pilasters to create additional support to the walls.
- Tie-rod must be taut to be



14.B Tighten the Tie rod, after finishing the belt, with the help of two nuts at each end. Place 75x75x5mm bearing plate in front of the nut before tightening.



Vertical leg of Belt
Special Shear Reinforcement



15. Where the belt alignment crosses an opening take the belt up or down around the opening.

Provide the additional shear reinforcement shown here in the vertical leg of the belt.



16. Place plaster in two coats, each 12mm (1/2") thick at an interval of 1 to 2 hours to provide 16mm (5/8") cover over the reinforcement.



17. Cure the plaster for 15 days.



3. Vertical Reinforcement

Disaster type: **E** **W**

Weaknesses in brick or stone masonry walls :

- Poor storey- to- storey connection.
- Poor wall to roof connection.

12

Where to apply remedy?

At all wall- to- wall junctions and at other locations in walls from foundation to roof.

To be applied in all buildings in Seismic Zones IV & V & in Wind Speed Zone III & IV, and in 2 and 3 storey buildings in Seismic Zone III.

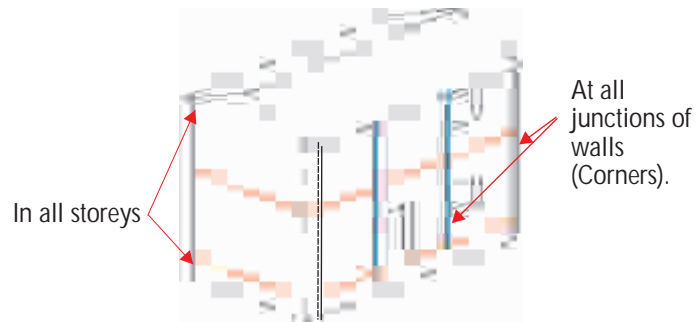

In all storeys

At all junctions of walls (Corners).

Options of Vertical Reinforcement:

A. Single reinforcing bar B. Vertical Belt with WWM and reinforcing bars.

Specifications:

1A. Bar or WWM belt sizes are given here for walls 5m. In length or shorter.

No. of storeys	Storey	Single Vertical Reinforcing TOR Bar Size ***			
		Seismic Zones Wind Speed Zone	Zone III	Zone IV Zone III	Zone V Zone IV
One	Ground			10	12
Two	Upper			10	12
	Ground			12	16
Three	Top		10	10	12
	Upper		10	12	16
	Ground		12	12	16

B. Vertical Belt with Welded Wire Mesh & Bars

Weld Mesh - N = No. of longitudinal wires in mesh; B = Width of finished belt ***

All Reinforcement in the belt should be Galvanized.

No. of storeys	Storey	Seismic Zones IV Wind Speed Zone III		Seismic Zones V Wind Speed Zone IV		Additional Bars
		WWM G13		WWM G13		
		N	B	N	B	
One	Ground	10	300	14	400	2 - 6mm dia.
Two	Upper	10	300	14	400	
	Ground	14	400	14	400	
Three	Top	10	300	14	400	
	Upper	14	400	14	400	6 - 6mm dia.
	Ground	14	400	14	400	6 - 6mm dia.

Note: WWM made of 13 gauge wires is recommended here since 10 gauge wire mesh is difficult to handle because of its stiffness.

*** : For all other situations see National Disaster Management Division, Govt. of India Guidelines or appropriate National Building Codes.

12

3. Vertical Reinforcement (cont.)

A. How to install Vertical Bar in a corner?



1. Using plumb-bob demarcate 100mm (4") wide patch at the corner on both walls. Remove the plaster from the marked area.



2. Rake all the mortar joints to the depth of 15mm (5/8").



3. Clean the surface with wire brush.



4. Remove 300 x 300mm patch of flooring and excavate to 450mm depth. In the excavation place a bar with bottom 230mm (9") bent in 'L' shape. The rod will pass through each intermediate floor.



6. Place 8mm TOR bars in the holes and connect them to the vertical bar making sure it is 35 to 50 mm (1 1/2" to 2") from both the walls.

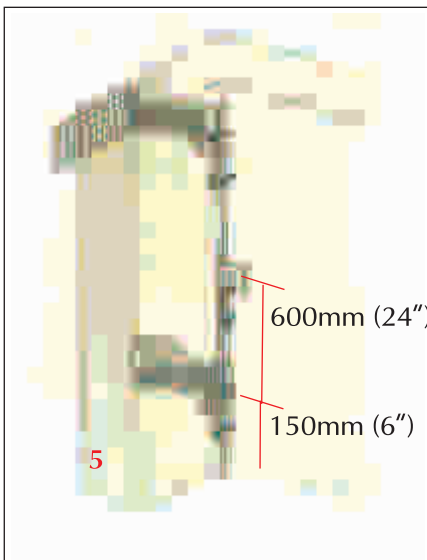

5. Make holes for shear connectors in both walls, starting on one wall at 150mm (6") from the floor, and then at every 600mm (24"), but in alternate walls.



7. Keeping vertical bar in plumb, pour the 1:2:4 concrete with continuous rodding in the hole in the ground to completely encase the bottom of steel rod in concrete.

Make sure to maintain 35 to 50 mm (1 1/2" to 2") gap between the vertical rod and both walls.



8. Clean all the shear connector holes and fill them up with non-shrink cement cum polymer grout. Making sure that bar is fully encased.

A. How to install Vertical Bar in a corner (cont.)?



9. Once all the shear connectors are grouted, clean the wall with wire brush and water. Install GI or timber centering for concreting.

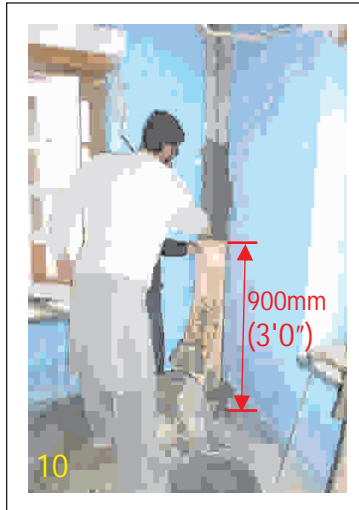

10. Do concreting in stages with their height not exceeding 900mm (3'-0"). Pour 1:1½:3 micro concrete with continuous rodding.

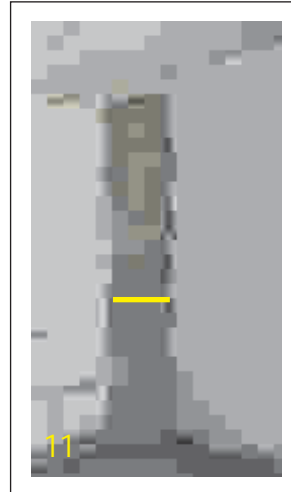

11. Once the concrete is set move the form-work upwards and continue concreting.

Ensure at least 15mm (5/8") concrete cover all around on the vertical bar.

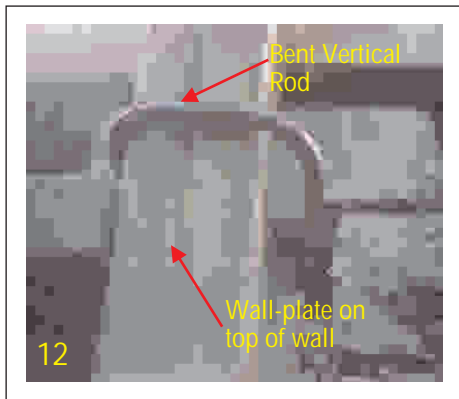

12. In a sloping roof with wooden wall-plate extend the bar above the top of the wall and bend it over the wall plate in order to anchor it to the wall.

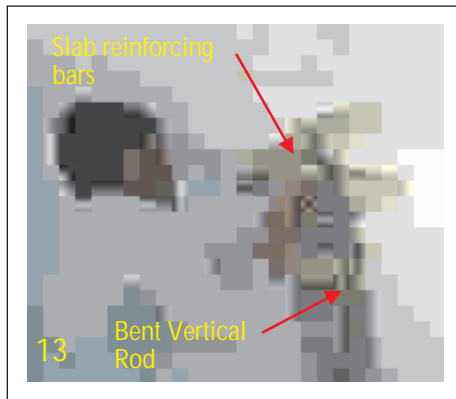

13. In RC slab, expose the slab reinforcing bars and connect the top bent portion of the vertical bar to the exposed bars using binding wires with minimum 300mm (12") overlap.



14. Wet the slab and apply neat cement slurry followed by cement mortar in 1:3. Finish it to match surrounding area. Cure for 15 days.

B. How to install Weld Wire Mesh Vertical Belt at wall junctions ?

When it is not possible to install vertical rod inside the room because of some obstruction the option of WWM Belt can be used on the outer face of walls.



1. Mark the belt alignment on the wall using plumb-bob.

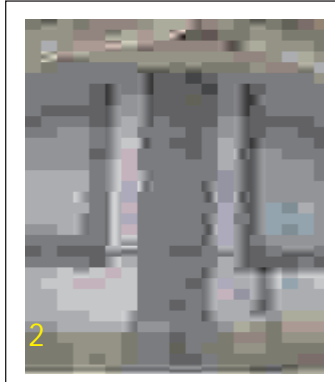

2. Remove the plaster from the marked area and expose the walling material.



3. Rake all the mortar joints to the depth of 12mm (1/2") by chisel or electric grinder. Clean the surface with wire brush.

12

B. How to install Weld Wire Mesh Vertical Belt at wall junctions (cont.)?

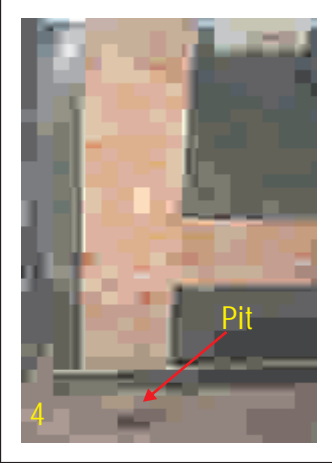

4. At the base excavate 400X150mm pit 300mm deep to anchor WWM in concrete.



7. In RR walls also use Cast-in-Situ RC Shear Connectors with 'L' shaped dowel bar to anchor the WWM.



5. Prepare the mesh straps of required length and width and attach to it the precut 6mm bars with binding wires.

Separate mesh from wall by placing 15mm (5/8") thick spacers

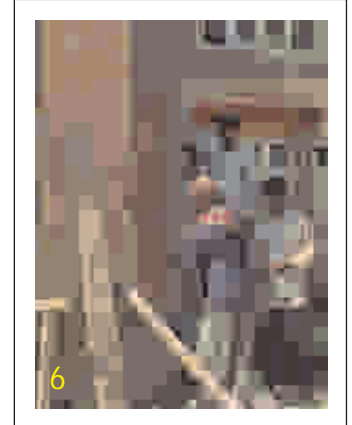

6. Install ready WWM strap. Use 100mm (4") long wire nails in bricks and square headed nails in stone at 300mm (12") spacing in staggered manner to anchor it.



8. Shear connectors are to be installed at a maximum spacing of 600mm (24"). Once the concrete hardens, attach WWM to it with binding wire.



9. Ensure continuity of WWM and bars through overlap joints. The minimum overlap shall be 300mm (12").



10. Splash the exposed wall surface with water. While still wet, apply neat cement slurry followed by first coat of cement-sand (1:3) plaster of 12mm (1/2") thickness.



11. After 1 to 2 hours apply second layer of plaster with the same mix to provide 16mm (5/8") cover over the reinforcement. Cure for 15 days.

4. Opening Encasement With Belt

Disaster type: **E** **W**

Weaknesses in Masonry Walls:

Diagonal cracking at openings because of:

- Capacity of wall to withstand tension reduced by door and window openings.

Where to apply remedy? On one face of a wall around every opening for door, and window

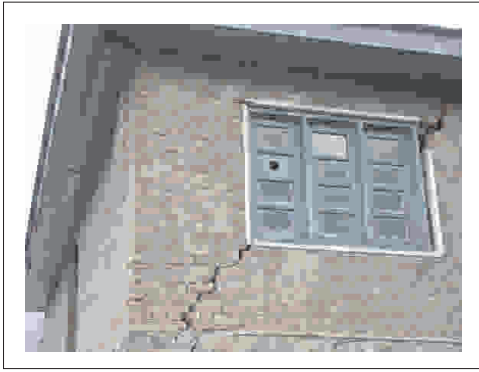

Specification of belt:

A. Galvanized 10 Gauge WWM - No. of wires = 10; Mesh width = 225mm; Belt width = 280mm.

Alternatively, for easier handling:

B. Galvanized 13 Gauge WWM - Plus 2-6mm dia. Galv. MS Bar.

C. If right WWM not available then use 8mm TOR rods with equivalent area of steel with 13 g GI wire tied crisscross.

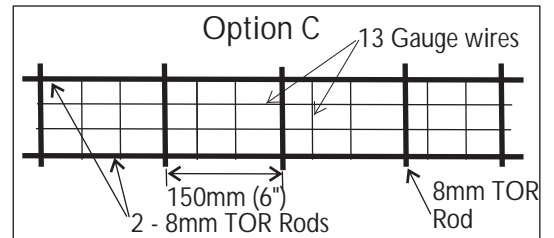
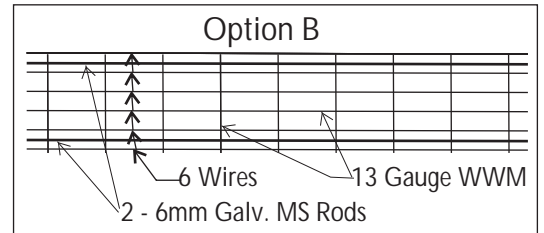

How to install Encasement Belt around opening?



1. Demarcate the belt around the openings. If lintel belt is installed, the encasement belt is required only on the side and under the window openings, and only on sides for door.



The installation procedure is exactly same as that used for the horizontal and vertical seismic belt.



4. Belts on all sides of encasement must overlap at corners.



5. The belts on top sides must overlap with the lintel level belt.



6. Merge two vertical belts in case the spacing between two openings is less than 560mm.

12

5. Diagonal Braces & Struts in Timber Floor/ Flat Roof Deck

Disaster type: **E** **W**

Weakness in Timber Floor/ Flat Roof :
Weakness against sideway forces causing distortions (rectangle becoming parallelogram) in floor / roof



Floor deck damage - Loosening of joints

Where to apply remedy? At the underside of floor and roof

Specification : The timber plank for bracings and struts :
100mm (4") X 25mm (1")

How to install timber struts and braces under flat deck?

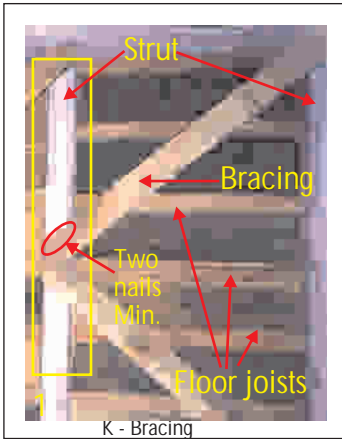

1. Install 2-100mm (4") x 25mm (1") struts (plank) on the underside of the floor beams next to where they are resting on walls with two nails/ screws at each end.



2. Pre-drill these planks to prevent splitting

Do not keep bracings too long. If possible nail them to each floor joist.

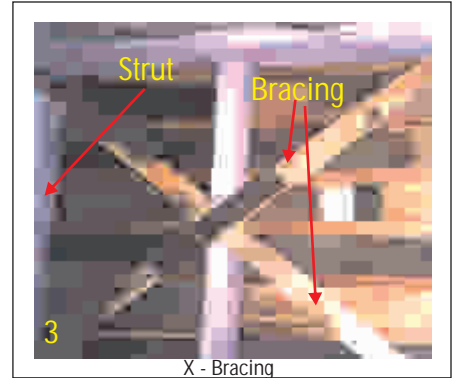

3. Install bracings in same way. Adopt "K" or "X" arrangement so that the angle between bracing and struts is close to 45 degrees.



4. Install more sets of bracings to cover more area of the deck.

5. Instead of two nails or screws for a stronger connection use 2 bolts with 3mm thick steel gusset plate.

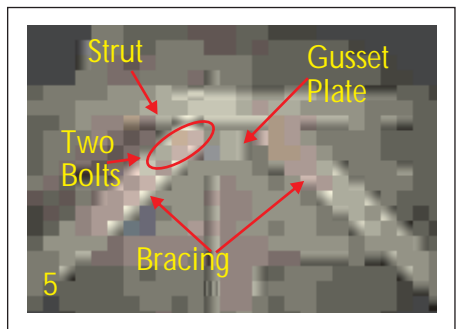

6. Collar Beam for Rafters in Pitched Roof Understructure

Disaster type: **E** **W**

Weakness in Sloping Roof :
Sideways push on walls from roof rafters resting on them because of:
• Flexibility in roof structure.

Specifications: Use pre- drilled Planks 35x100mm (1 1/2" x 4") in

How to install Collar Beam / Horizontal Tie?

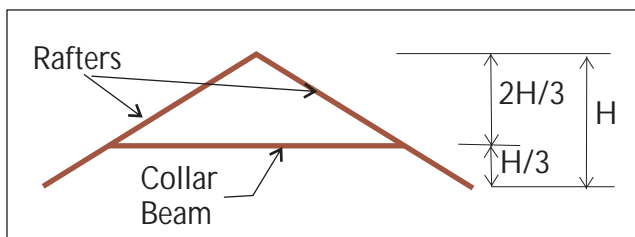

Install Collar Beams as shown above. Ensure proper level using water tube.

Where to apply the remedy?
Between the opposite pairs of rafters.



Use 2-10 g 75mm long wire nails or 2- 5mm bolts for fixing plank to the rafter at each end.

7. Timber Roof & Floor Anchor to Masonry Wall

Disaster type: **E** **W**

Weakness in Wooden Roof/ Floor supported on Masonry Walls:
Roof and walls are not connected to each other. So walls are unsupported at top and hence, more vulnerable.

Specification : "L" shaped bracket of MS angles 50x50x3mm with both legs 220mm long having 3-15mm dia. holes,



Alternatively, bracket with 150x150x3mm MS plate having two holes for better connection with wall.

How to anchor roof/floor deck to the masonry walls?

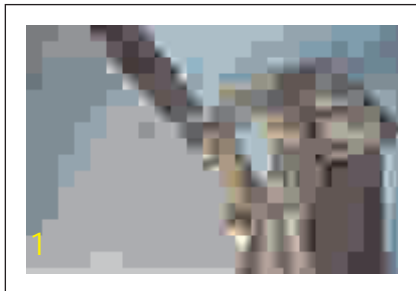

1. Drill holes at a suitable location in walls using 15mm dia. bit.

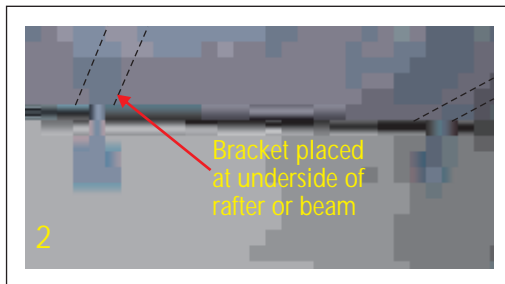

2. Install brackets on the wall using 12mm dia. Bolts with mechanical anchor such as expansion bolt.



3. Connect bracket to the underside of wood beams with 2-12mm dia. bolts placed through the beams.

8. Diagonal Bracings & Struts in Pitched Timber Roof

Disaster type: **E** **W**

Weakness in Pitched Timber Roof :
Weak against sideway forces causing distortions (rectangle becoming parallelogram) of timber framing and resultant damage to gable walls.

Where to apply remedy? At the underside of the rafters or purlins.

How to install bracings & struts under roof?



Roof distortion damage

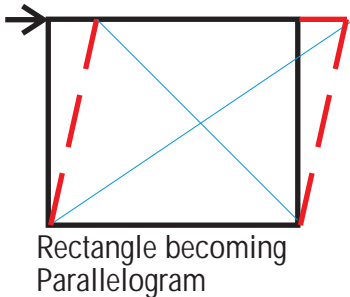

Two bolts with gusset plate make stronger connection.

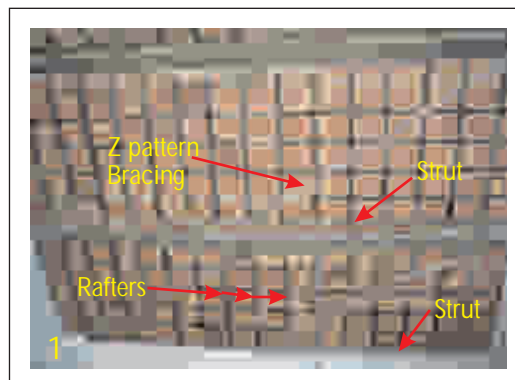

Roof with Rafter from Ridge to Eave

Install struts as shown in photos. Install Bracing in K, Z or X pattern. Use 100mm (4") x 25mm (1") or heavier planks. Pre-drill the planks as well as principal rafters to prevent splitting. Use 2 nails at each joint.

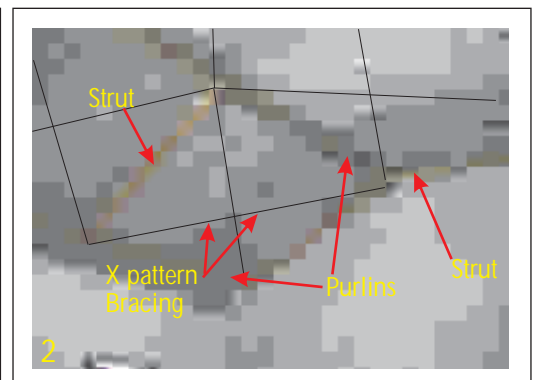

Roof with Purlins from Gable to Gable

Alternately, a cheaper and simpler option:
Make X-Bracings of four 13 gauge GI wires tied to strut and twisted to pre-tension them.

12

9. Knee Braces at Beam-Column joint

Disaster type: **E** **W**

Weakness in Beam-to-Column Connection:

Weak flexible connection allows excessive sway of timber frame that results in damage to walls.

How to install Knee Braces?

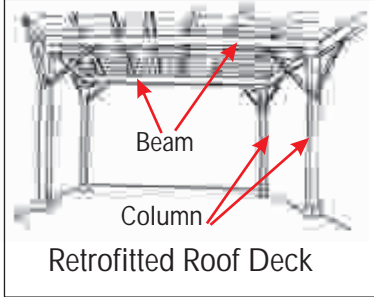

Install one knee brace for each beam resting on column from different direction.

Knee brace can be made of MS Angles, MS Pipes or timber.

Knee brace connection to column and beam must be able to take tension and compression.

Knee brace should be heavy enough to resist buckling under pressure.

10. Jacketing of Masonry Column

Disaster type: **E**

Weakness in Masonry Column:

Bending of column by lateral forces causes cracking because column has no ductility.



Remove plaster and rake the joints.

Fill holes with non-shrink grout.



Install 8mm TOR shear connectors in pre-drilled holes in columns for anchoring 8mm TOR vertical rods to them.

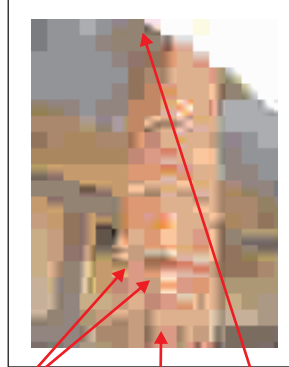

Install two 8mm TOR rods on each face along with 6mm rings at 300mm c/c.

At top connect the bars with rebars of slab or beams with adequate overlap.

How to Jacket a column?



Cover all reinforcement including joint at top with 1:4 cement mortar.

11. Anchoring Roofing Tiles & Sheeting to Understructure

Weakness in Tile Roofing:

Absence of anchoring results in tiles and sheeting getting blown off.

Disaster type: **E** **W**

How to anchor roof tiles and sheeting to understructure?



Install a GI wire hook under every tile attaching it to purlin.

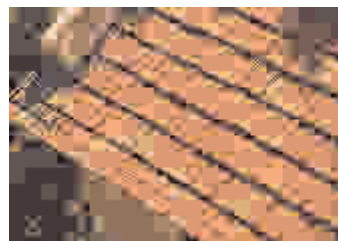

Install two 10 ga. GI wires on the lowest row of tiles from one end to other.



Install RC Strips 100X100mm with 10mm dia TOR bar at max. spacing 1200mm.

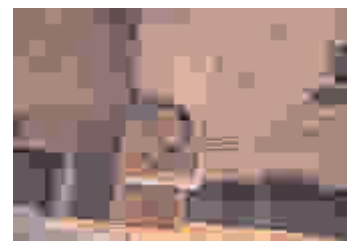

Install U-hooks to anchor sheet roofing to purlins.

Details for all these items are given in Chapter 7 on "New Construction"

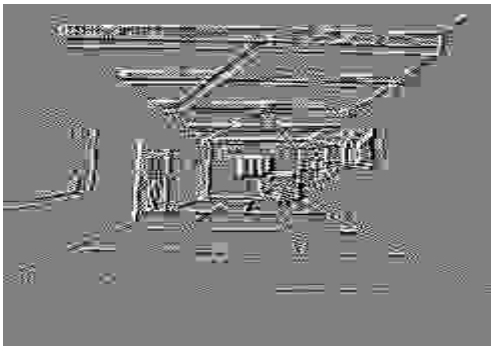

By now the reader must have understood the retrofitting measures that are necessary in his area. After selection of the measures to retrofit a building the main question that he will be faced with is "what quantity of materials are needed" and "how much money he will have to spend".

How to use the Material Quantity information? :

- Here for a specific quantity of each feature the quantities of material required such as cement, steel bars, sand, aggregates etc. are given.
- The user has to finalize which features he is going to use and determine the quantity of each feature.
- Next, with that quantity in hand use the information provided in this Chapter.
- Simply multiply quantity of a particular feature to the material quantities provided in this Chapter to arrive at the total quantity of material required.
- For each material quantity the commonly used measuring systems are adopted to make it easy for user as well as for ease of ordering the materials.

Material quantities listed here are applicable to one or more of the Seismic Zones III, IV and V, and Wind Zones III and IV as indicated in Chapter 11 & 12.

Restoration Features

Item no.1.

G-1 & G-2 Crack sealing with 1:3 Cement Sand mortar.

Material quantities: For 10m length of Crack	
Cement	0.004 Cu.m = 0.13 Bags
Sand	0.01 Cu.m = 0.003 Brass

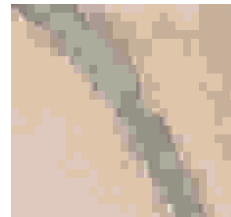

Item no. 2.

G-3 Crack grouting using appropriate grouting plasticizer in (a) 350mm thick Brick wall with 30% cavity in crack and (b) 450mm thick UCR wall with 150% cavity.



Material quantities: For 10m (32' 9 1/2") length of Crack		
	Brick Masonry	UCR Masonry
Cement	0.01 Cu.m = 0.2 Bags	0.04 Cu.m = 1.2 Bags
Sand	0.013 Cu.m = 0.01 Brass	0.01 Cu.m = 0.03 Brass
Grouting Plasticizer	0.03 Liter	0.2 Liter

Item no. 3.

Crack Stitching Strap 280 mm wide with 250 mm wide WWM having 9 - 13 gauge wires longitudinally and cross wires at spacing of 75mm and covered in 35mm thick cement mortar.



Material quantities: For 10m (32' 9 1/2") length of Crack stitching	
Galvanized WWM -13gauge 25mmx75mm	= 2.3 Sq.m
5mm thk. 100mm (4") long Galvanized Nails with washer	= 4.5 kg.
Cement	= 0.03 Cu.m = 0.9 Bags
Sand	= 0.1 Cu.m = 0.03 Brass

13

Retrofitting Features

Item no.1.

100mm dia. Cast In-situ Concrete Bond Element cum Shear Connector with 8mm TOR rod reinforcement and infill of Concrete 1:2:4.



Material quantities : for 10 no. of Bond Elements		
	225mm thk. Wall	450mm thk. Wall
Cement	0.004 Cu.m = 0.11 Bags	0.01 Cu.m = 0.25 Bags
8mm TOR Steel Rods	2.8 kg.	3.7 kg.
Sand	0.01 Cu.m = 0.003 Brass	0.02 Cu.m = 0.01 Brass
Aggregates	0.02 Cu.m = 0.01 Brass	0.031 Cu.m = 0.011 Brass

Item no 2.

Vertical bar at corners encased in 100x100mm (4"x4") triangle of 1:1.5:3 micro concrete.



Material quantities: for 10 meter length of the Vertical Bar with bottom 400mm bent in 'L' shape			
Cement	0.1 Cu.m = 0.4 Bags		
Sand	0.021 Cu.m = 0.01 Brass		
Aggregates	0.04 Cu.m = 0.02 Brass		
Steel	10mm dia.	12mm dia.	16mm dia.
	8.64 kg.	12.5 kg.	22.1 kg.

Item no.3.

Vertical bar bottom anchor 450x300x300mm (18"x12"x12") filled with 1:3:6 micro concrete.

Material quantities: for 10 no. of Vertical Bar Anchor at Bottom	
Cement	= 0.06 Cu.m = 1.748 Bags
Sand	= 0.19 Cu.m = 0.065 Brass
Aggregates	= 0.369 Cu.m = 0.13 Brass



Item no.4.

Vertical bar RCC slab roof anchor covered in 1:1½ :3 micro concrete or Cement Mortar (1:3).

Material quantities: for 10 no. of Vertical Bar Anchor with RC Slab	
Cement	= 0.01 Cu.m = 0.25 Bags
Sand	= 0.01 Cu.m = 0.004 Brass
Aggregates	= 0.02 Cu.m = 0.01 Brass



Item no 5.

Vertical WWM Strap 400 mm wide made with WWM having 14-13 gauge galvanized wires in longitudinal direction and cross-wires at 75mm spacing plus 2-6mm dia. MS bars and 1-12mm TOR bar (for lower storey only) and covered in 35mm thick 1:3 Cement plaster.

Material quantities: For 10m (32' 9 1/2") length of Vertical WWM Strap			
	Top storey	Top storey	Lower storey
GI WWM -13 gauge 25mmx50mm	0.25 Sq.m	3.50 Sq.m	
6mm MS Steel Rods	= 4.5 kg.		
12mm TOR Steel Rods	0	0	9.0 kg.
Cement	0.33 Cu.m = 1.0 Bags	0.044 Cu.m = 1.32 Bags	
Sand	0.1Cu.m = 0.035 Brass	0.14Cu.m = 0.049 Brass	
5mm thk. GI Nails with washer	= 6.7 kg.		



Item no 6.

Vertical WWM Strap bottom anchor 400x150x300 (16"x6"x12") filled with 1:3:6 concrete.



Material quantities: For 10 no. of Vertical WWM Strap Anchor at Bottom	
GI WWM -13 gauge 25mmx50mm	= 0.9 Sq.m
6mm MS Steel Rods	= 1.8 kg.
12mm TOR Steel Rods	= 3.6 kg.
Cement	= 0.03 Cu.m = 0.8 Bags
Sand	= 0.1 Cu.m = 0.03 Brass
Aggregates	= 0.2 Cu.m = 0.1 Brass

Item no 7.

Vertical WWM Strap top anchor covered in 1:1½ :3 micro concrete or (1:3) Cement Mortar.

Material quantities: For 10 no. of Vertical WWM Strap Anchor to RC Slab	
GI WWM -13 gauge 25mmx50mm	= 0.7 Sq.m
6mm MS Steel Rods	= 1.33 kg.
12mm TOR Steel Rods	= 2.7 kg.
Cement	= 0.01 Cu.m = 0.14 Bags
Sand	= 0.01 Cu.m = 0.003 Brass
Aggregates	= 0.02 Cu.m = 0.01 Brass



Item no 8.

Horizontal Belt 280 mm wide with 250 mm wide WWM having 9 - 13 gauge longitudinal wires and cross wires spacing of 75mm, plus longitudinal 6mm dia. MS bar covered in 35mm thick 1:3 Cement plaster.



Material quantities: For 10m (32' 9½") length of horizontal belt								
		< 5mt. wall.		up to 6mt. wall.				
GI WWM -g13 25mmx50mm								2.3 Sq.m
5mm thick GI Nails with washer								4.5 kg.
Cement		0.024Cu.m=0.73Bag						0.01 Cu.m = 0.14 Bags
Sand		0.08Cu.m=0.03Brass						0.1 Cu.m = 0.033 Brass
6mm MS Steel Rods		2no.	4.5 kg.	2no.	4.5 kg.	< 5mt. wall.		up to 6mt. wall.
						2no.	4.5 kg.	4no.

Item no 9. 12mm dia. MS Tie Rod with 100mm long threading at both ends with 2 nuts and 100x100x5mm MS bearing at each end.

Material quantities: For 10 m length of Tie Rod	
12mm dia. TOR Steel Rods	= 9.0 kg.
Steel - MS Bearing Plates - 2 ea.	= 4.7 kg.
Misc.- Nuts, threading, washers etc.	= 20.0 no.
Cement	= 0.02 Cu.m = 0.5 Bags
Sand	= 0.03 Cu.m = 0.01 Brass
Aggregates	= 0.06 Cu.m = 0.02 Brass



13

Item no 10.

Jacketing of 350x350mm (14"x14") brick column with 8 - 8mm TOR rods and 6mm stirrups at 300 c/c covered in 1:4 Cement mortar.

Material quantities: For 10m (32' 9½") height of Column	
6mm MS Steel Rods	= 12.25 kg.
12mm TOR Steel Rods (Main bars)	= 31.6 kg.
Cement	= 0.04 Cu.m = 1.25 Bags
Sand	= 0.17 Cu.m = 0.06 Brass



Item no 11.

Brick Column jacketing shear connector 8mm TOR dowel 150mm long, embedded 150mm (6") deep in brick masonry and grouted with appropriate non-shrink grout (1)Non-shrink. Cement : (1) Water.

Material quantities: For 10 no. Brick Column Shear Connector.	
Steel - 8mm TOR	= 1.2kg.
Non - shrink Cement	=0.4kg.



Item no 12.

Timber Attic floor anchor to wall made of 50x50x3mm L shape MS Angle with 300mm(12") long each leg mounted on wall with 4 - 12mm dia. bolts and connected to floor joist with 3-12mm dia. Bolts.

Material quantity: For 10 no. of Anchors	
Anchor Brackets - MS Angle 50x50x3mm, 12"x12" with three 13mm holes in each leg.	13.80 Kg.
10"Long 12 mm dia. Bolt with 2 no. Washers & 1 no. nut.	30 no.
8"Long 8 mm dia. Mechanical Fasteners with 1 no. washers & 1 no. nut.	40 no.



Item no. 13

Wooden Diagonal Bracing (K) & Struts For Floor and Roof Framing .

Material quantities: For 10 Sq.m of Floor/ Roof area	
100mm (4") x 25mm (1") timber plank	= 0.03 Cu.m
4 nails / plank -10gauge 100mm long	= 16 no.



Item no.14.

Diagonal GI Wire Bracing (X) & Wood Struts for Roof Framing: Struts made of timber planks and bracings made of 4 strands of twisted Pre-tensioned 13gauge GI wires.

Material quantities: For 10 Sq.m of Roof area	
100mm (4") x 25mm (1") strut (plank)	= 0.2 Cu.m
10 gauge Nails 100mm long	= 8 no.
13 gauge GI Wire	= 1.0 Kg



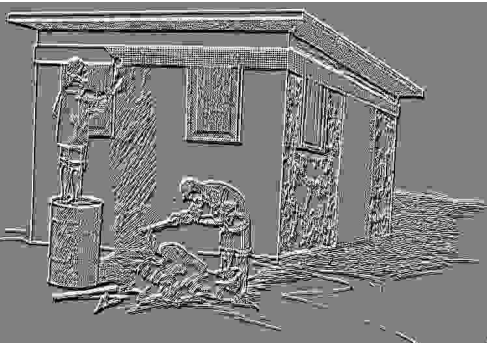

While doing Restoration & Retrofitting pay attention to following principles of good practice:

Belt & Vertical Reinforcement

1. Study the building and the levels of door and window lintels to decide the exact alignment of full belt before starting its installation to avoid unexpected obstructions later.



2. Use tube level to mark out the belt alignment and use electric grinder to make a groove along the top and bottom of belt alignment in order to minimize damage to plaster during its removal and thus reduce the cost.

3. Rake all joints 15mm (5/8") deep and clean the wall surface with wire brush and then with water to ensure good bond with the wall.

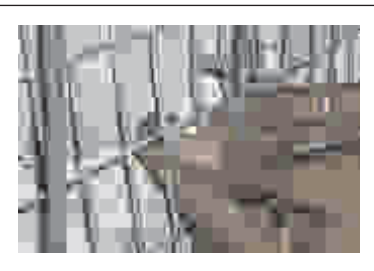

4. Ensure total encasing of WWM and bars in cement mortar by keeping a 12mm (1/2") gap between wall and WWM with the use of some spacers such that the mortar covers it from behind.



5. Use galvanized WWM for all applications on exterior face of wall to prevent corrosion.



6. End of WWM belt must always overlap with other WWM belt or a steel rod for continuity.

14

Vertical Reinforcement

7. Ensure adequate all around concrete cover on Vertical Reinforcement by ensuring a gap of 38 to 50mm (1½" to 2") between the rod and the wall.

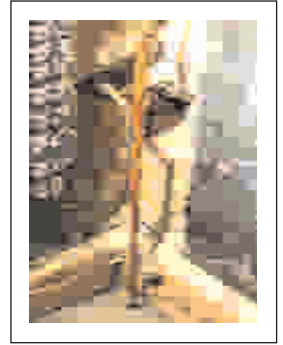

8. Concrete for encasing vertical reinforcement should contain aggregates no larger than 12mm (½") and concreting should be accompanied by continuous rodding for proper encasing in concrete.

Shear Connectors & Bond Elements

1. Make dumbbell shaped holes with its core just wide enough to permit the insertion of the 8mm TOR rod with hooked end in order to ensure its effectiveness in holding the wythes (wall faces) together and to reduce mortar consumption.

In RR masonry use aggregates no bigger than 6mm (¼") in concrete. In brick masonry use mortar instead of concrete with coarse sand.

Reinforcing bars must be fully encased in concrete.



Roof & Floor

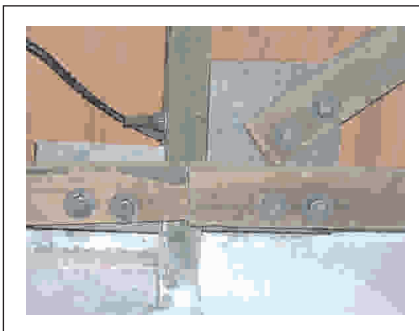

1. Use of gusset plate with at least two bolts in installing bracing and struts is stronger than that with nails.

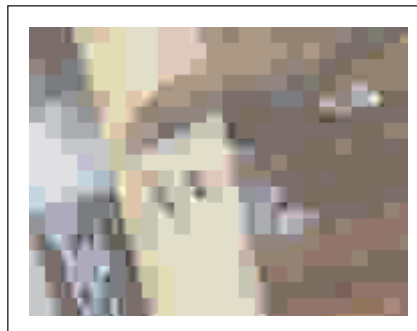

2. If nails are used for connection of timber struts and bracing use a minimum of two nails or screws for each joint.

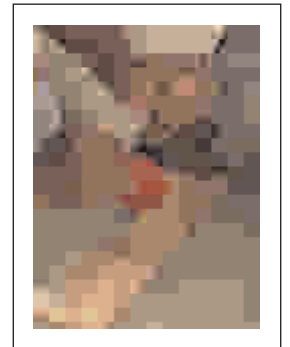

3. Pre-drilling is desirable with timber to prevent cracking.

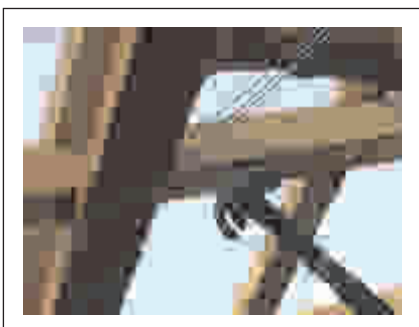

4. If bracing is made of multiple strands of GI wires then use carpenter's hammer to pull each wire tight during installation.

5. Twist all wires along one diagonal in the bracings together with the help of a 150mm (6") long MS rod for pre-tensioning.



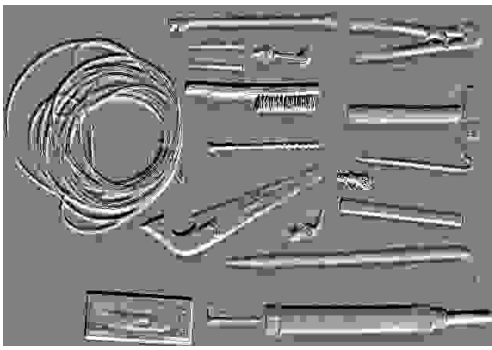

Having a right tool on hand for each restoration and retrofitting activity is important. It will reduce the effort, increase speed and improve the quality of work.

Restoration and Retrofitting involve a few activities that are not carried out in routine construction. These activities require special tools that are not commonly found at a construction site. The list presented below consists mainly of such tools that ought to be procured and kept readily available at site prior to taking up restoration and retrofitting activities. The power tools are optional. But if electric power is available then these tools can not only help in doing a neat job but also greatly expedite the work.

For Wall Preparation & Making Holes

Safety goggles.

Electric grinder for plaster cutting

Power drill with long extension cord

Drill bits of 12mm (1/2"), 16mm (5/8"), 20mm (5/6"), 300mm (12") long.

Brick masonry hole making tool 35mm (1 1/4") dia. GI pipe 300mm 12" and 450mm 18" long

Wire brush to clean the wall

Stone extraction tools

Tool for raking mortar joints

Hammer

Stone extraction rod

Bar bending set

For Shear Anchors and Concreting

Sheet metal for form work of corner vertical reinforcement concreting

Different size chisels for cutting steel rods, WWM and concrete

tongs to hold chisel

5 kg. Sludge hammer

Bar bending tools

Pliers with wire cutter

Spanners for the wall anchor bolts

Tools and Equipment For Retrofitting & Restoration

15

For WWM Belt

Heavy duty wire cutter

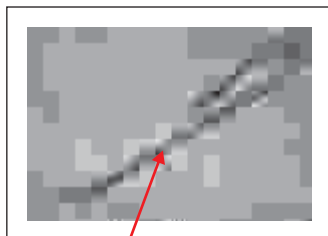
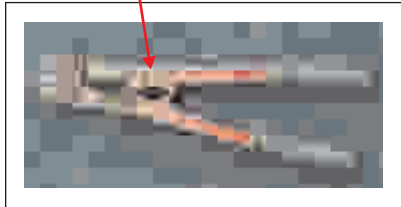

Binding Wire tightening tool

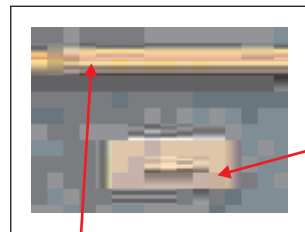

Trowel

50x25mm (2"x1") wood batten for forming the lower edge of belt plaster, or an aluminum straight edge 1.82m (6' 0") long.

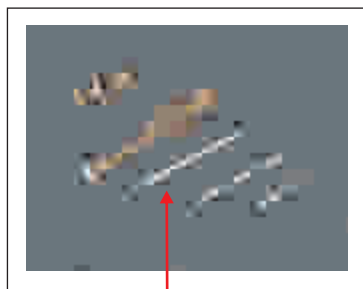

Bolts & Nails



Hand drill

Belt Alignment Marking tools

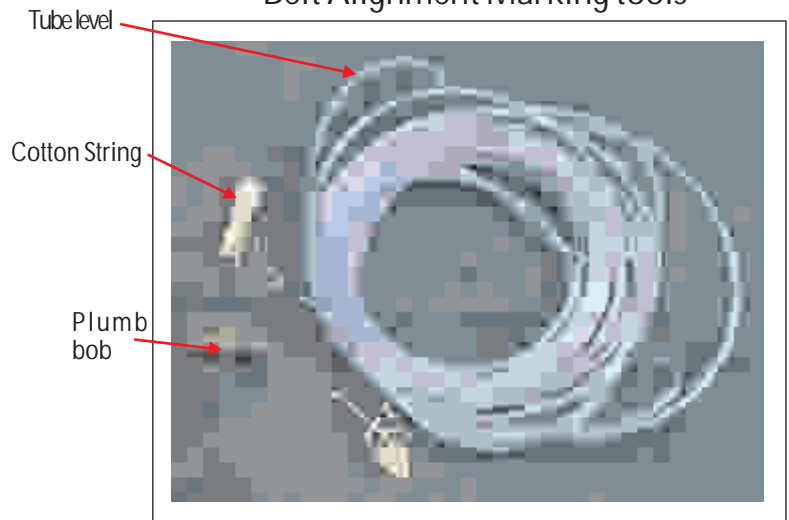

Tube level

Cotton String

Plumb bob

Simple Grouting Equipment

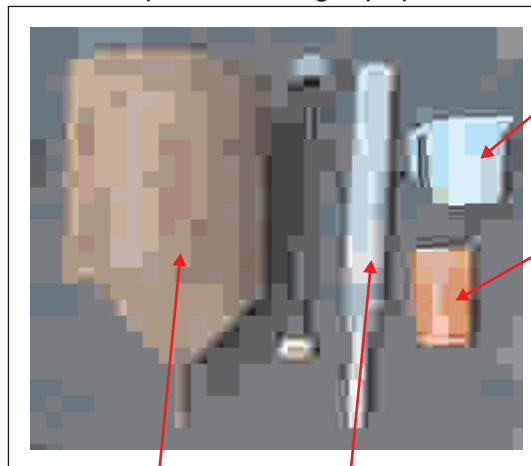

Grouting Canister

Grouting Hand pump

Grout pouring mug

Additive measuring cups

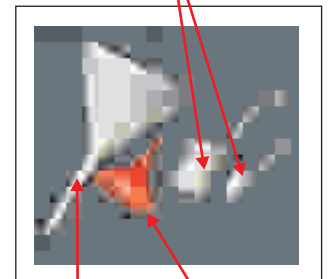

Big Funnel

Small Funnel

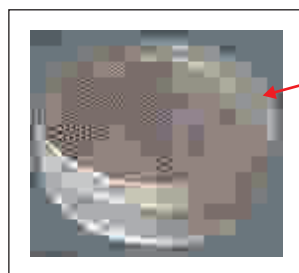

Sieve

Carpenter's Tools

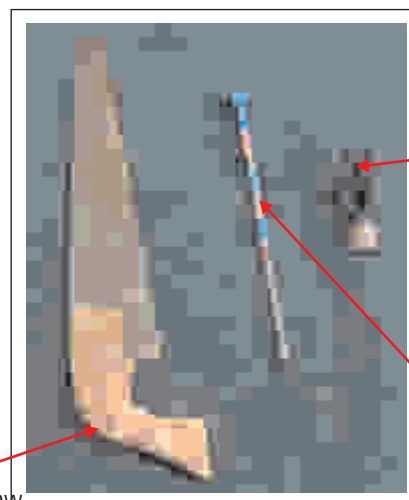

Carpenter's hammer

Hand drill

Carpenter's saw

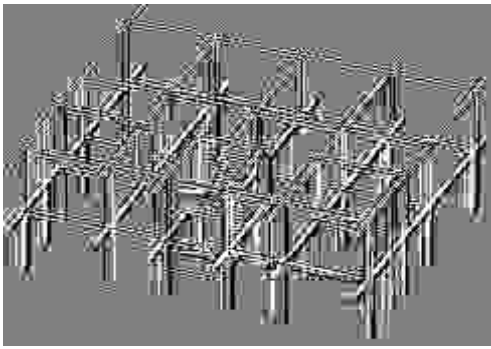

Poor Performance of RCC Structures

It is the mistakes that make a structure weak and vulnerable against forces of nature. So it is important for those building RCC structures to understand the correct way of building them and follow the basic rules.

Before Kutch Earthquake most people thought that RCC structures would never collapse. But the earthquake showed them that they were wrong. Every one has seen cracks in beams, columns and slabs, and chunks of concrete separating from the underside of slab and falling, and exposing the corroded bars.



Corrosion Damage



Collapse in earthquake

1. Purpose and Limitations :

The technology of RCC structure is based on scientific principles. Its design involves use of these principles. Each situation demands a new design that meets the requirements of that situation. For some one to carry out such a design he must have the necessary engineering knowledge. But for those who do not have this knowledge and still want to plan and build small RC structures, it is important that they know some basic rules that are given here so that major mistakes are avoided. It is, however, not possible to give rules that would help the builder decide the size of different components and the number of reinforcing bars to be used. Nonetheless, it will be best if an engineer's advise is taken.

In this Chapter the numerical information given under 3. Sketches of RCC Construction Details is applicable to small size structures that are commonly built without the involvement of engineer. The maximum sizes of various components in such a building are given below including size of RC slab, beams and columns. In addition the commonly used bar sizes are also given. Seek advise of an engineer for buildings with bigger components.

Caution: The guidance given in this chapter is for buildings having no more than 2 storeys, room dimensions no more than 5m and storey height no more than 3m.

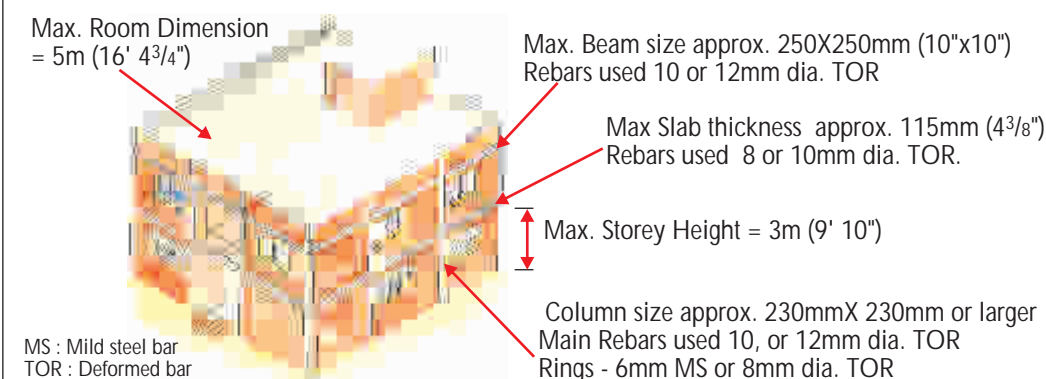

16

2. Precautions to be taken in RCC Construction

A. For small structures 43 grade cement is preferred over 53 grade cement.

B. Always use fresh cement. Do not use cement which is six months old or older.

C. Use no larger than 20mm (3/4") aggregate.

D. Use 300x300x300mm (12"x12"x12")-3"box for exact measurement of ingredients.

E. Use of machine for mixing concrete preferred.

F. If machine is not available then mix dry cement and sand first with hands. Then add aggregates and mix everything three times. Next add water and mix it thoroughly until the color is uniform and is of desired consistency.

F. Volume of water used in preparing the concrete should not be too little or too much.

For 100 cubic feet of concrete add 6 to 10 cubic feet of water. For 1cu.m of concrete add 60 to 100 litres of water.

The water should be clean. Water fit for drinking is best for concrete. Sea water must never be used

G. Reinforcing bars must be clean, free from loose rust, and coating of paints, oil, mud, dirt etc.

Any impurity on bar weakens the bond between steel and concrete

H. Always use spacers to lift the reinforcement so that they get the required concrete cover. Make spacers at site with 1:3 cement mortar and binding wire.

I. All cantilevered slabs must have main reinforcement bars near the top and not near the bottom and anchored fully at the back to heavy stabilizing weight.

J. When the slab continues over a wall or beam to the next room, always crank up alternate bars or provide extra pieces of steel as it goes over the wall or the beam.

K. Once the concrete is placed, rodding must be done with steel bar, or a vibrator to remove all the air from the concrete.

L. Do not use weak centering. Use good quality centering that does not deform when concrete is placed.

M. Keep RC work wet for minimum of 15 days.

3. Sketches of RCC Construction Details

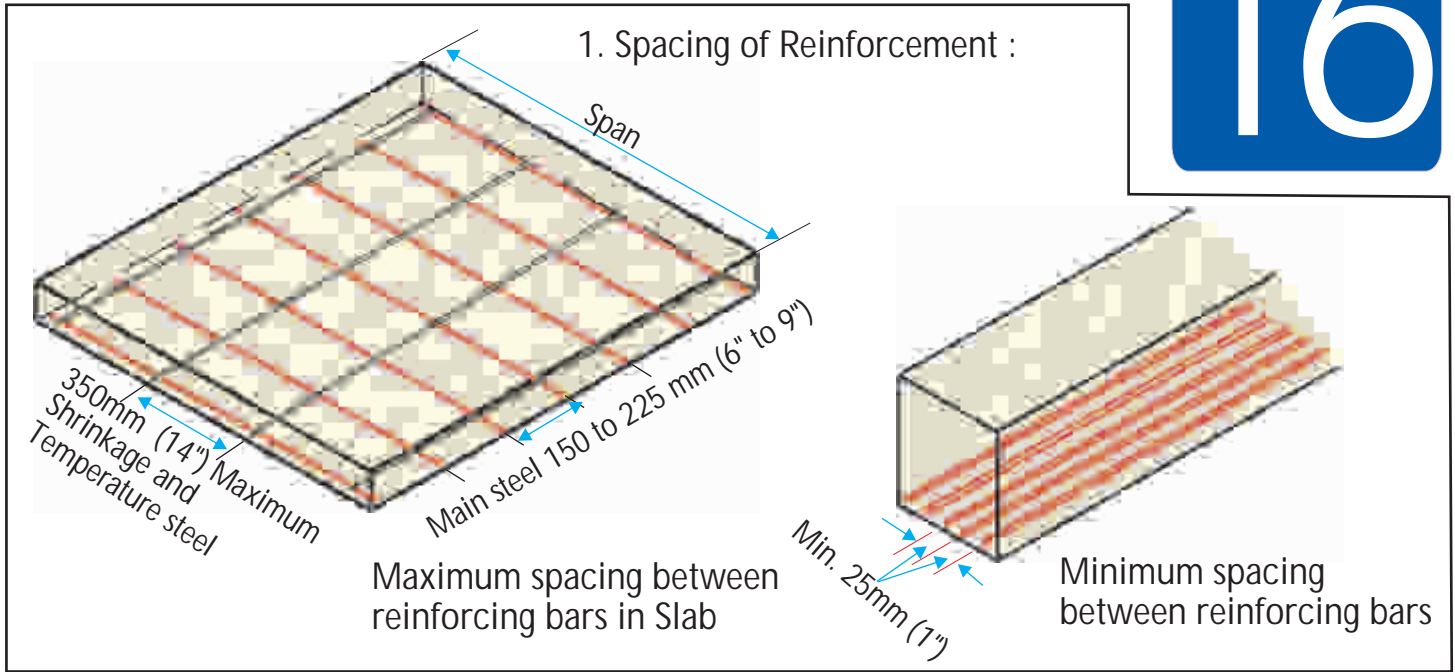

2. Minimum Concrete Cover for reinforcement

In slab and beam in coastal areas with high humidity the minimum cover should be 30mm (1¹/₅")

Beam - Connected to Columns

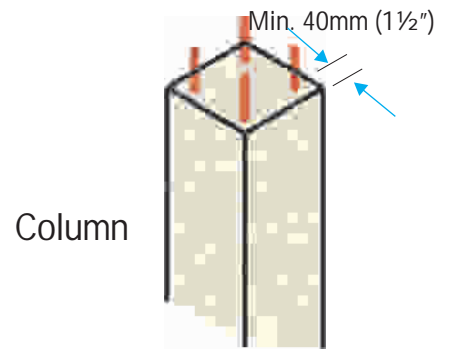
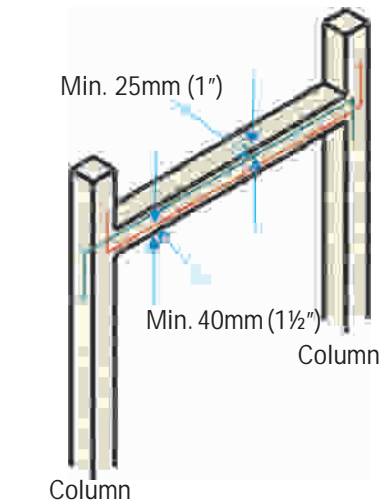

Slab - Continuous Over Support

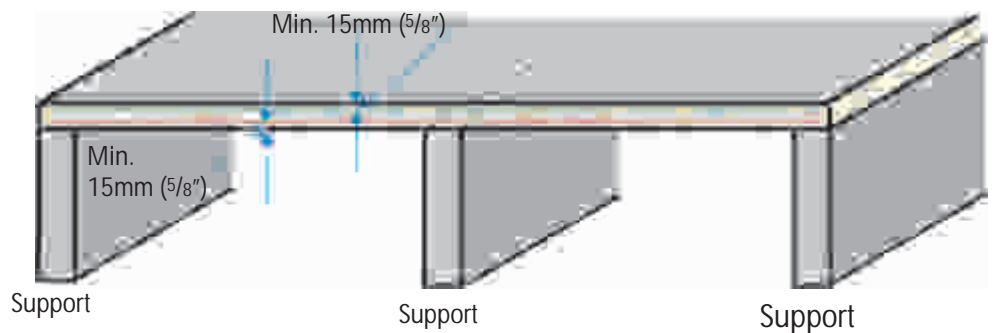

Beam - Simply Supported

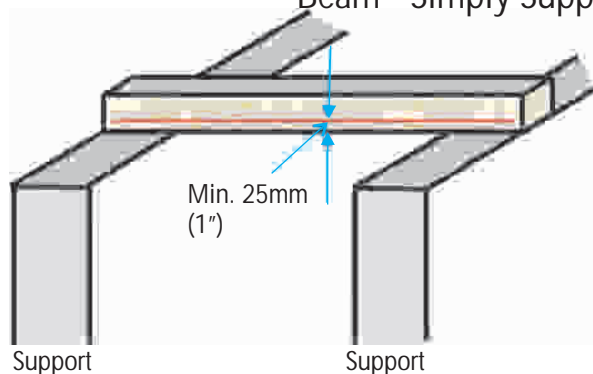

Slab - Simply Supported

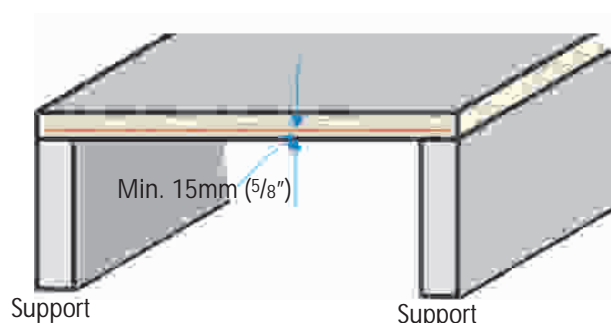

16

3. Reinforcement Arrangement in Continuous Beam (Equal or nearly equal spans and uniformly loaded)

At least two straight bars must be provided at top and at bottom in the entire length of the beam in addition to the bars shown here.

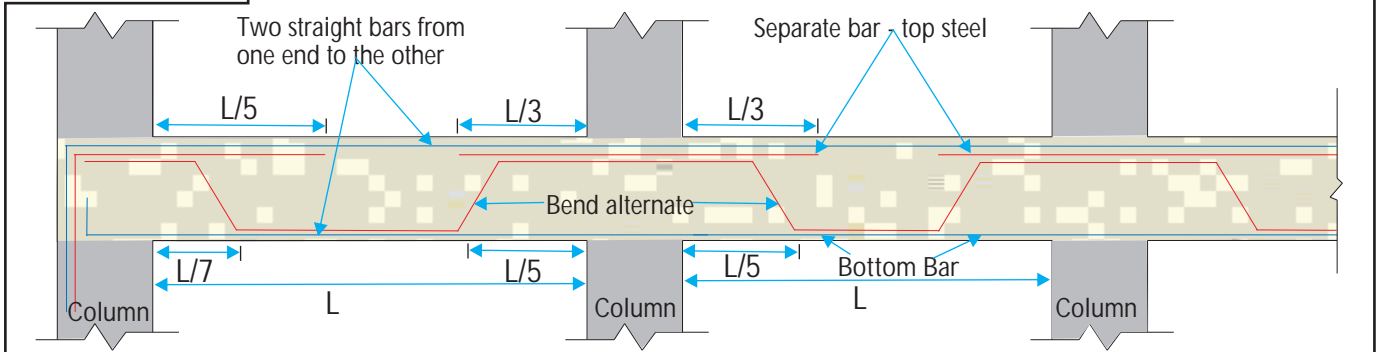

4. Suggested Tie/Ring Spacings for Beams

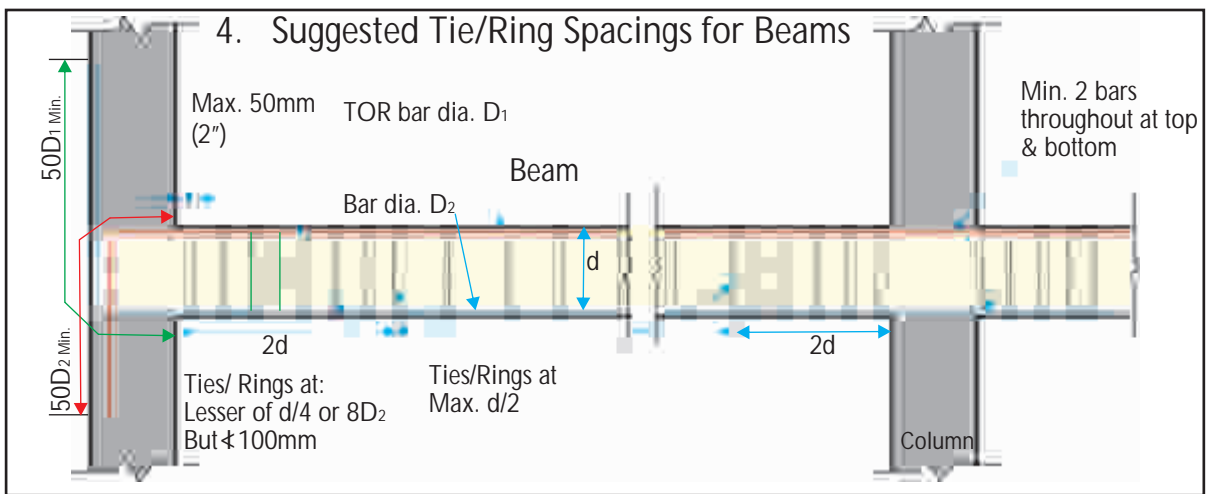

5. Anchorage of Bars: Minimum requirement

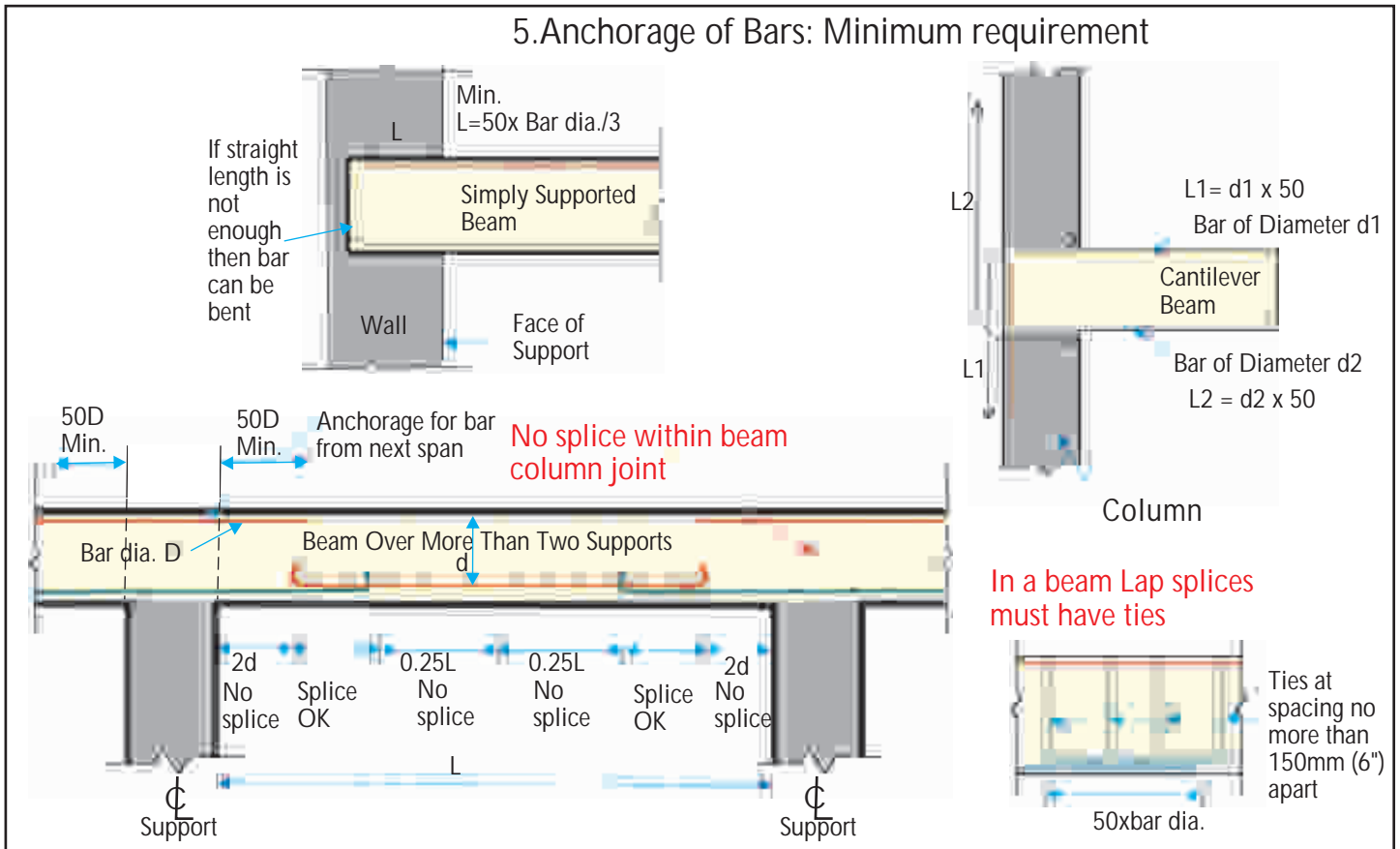

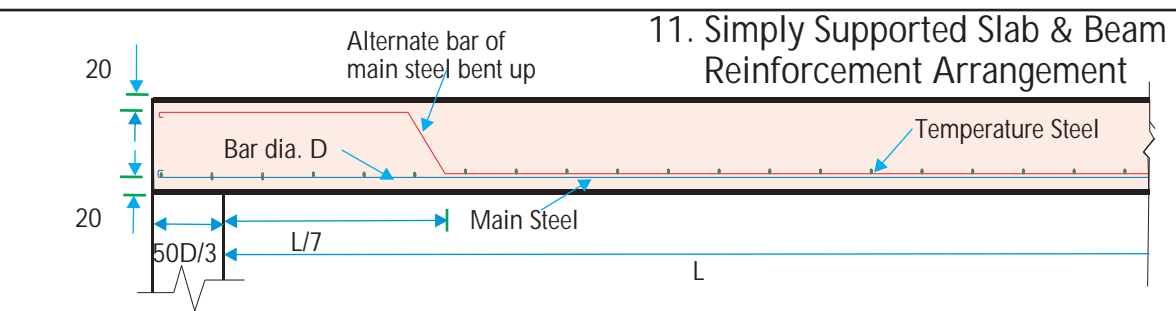
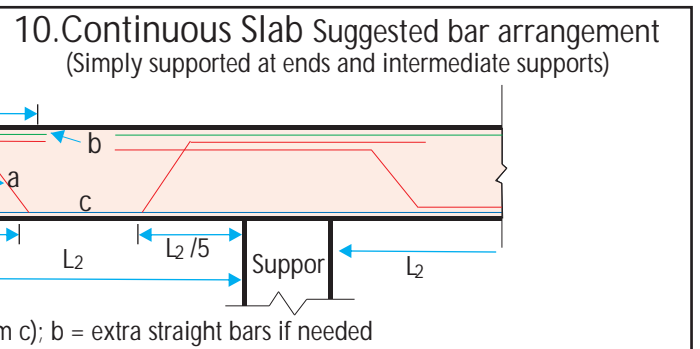
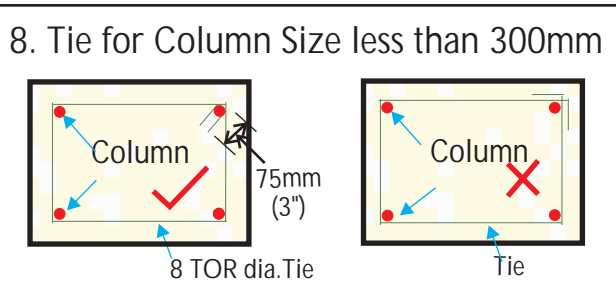
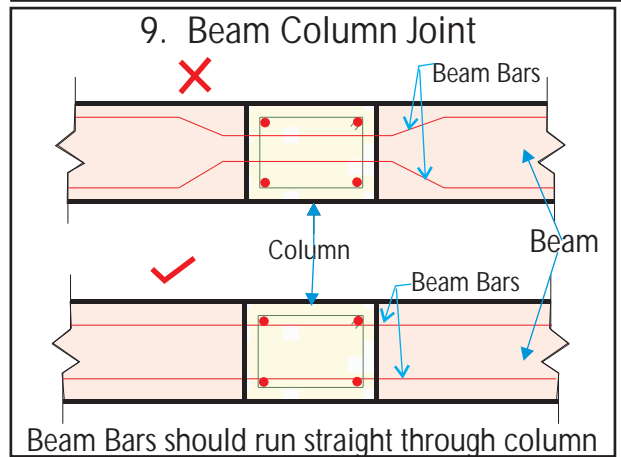
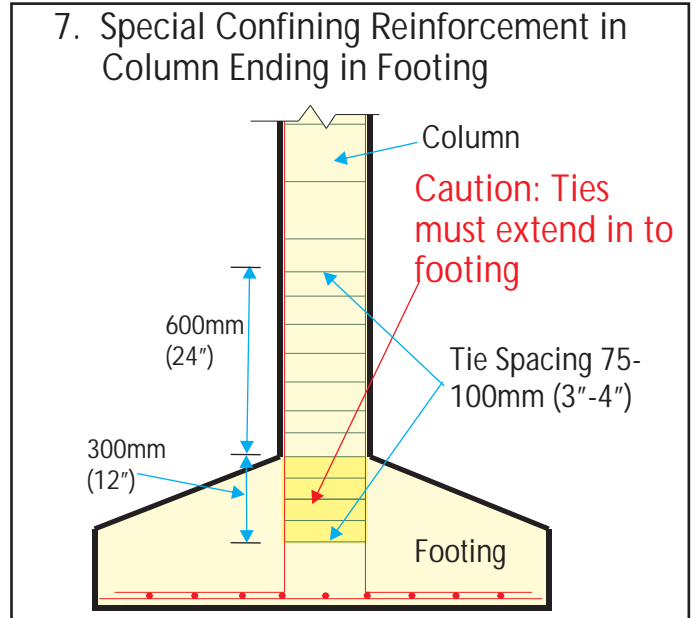
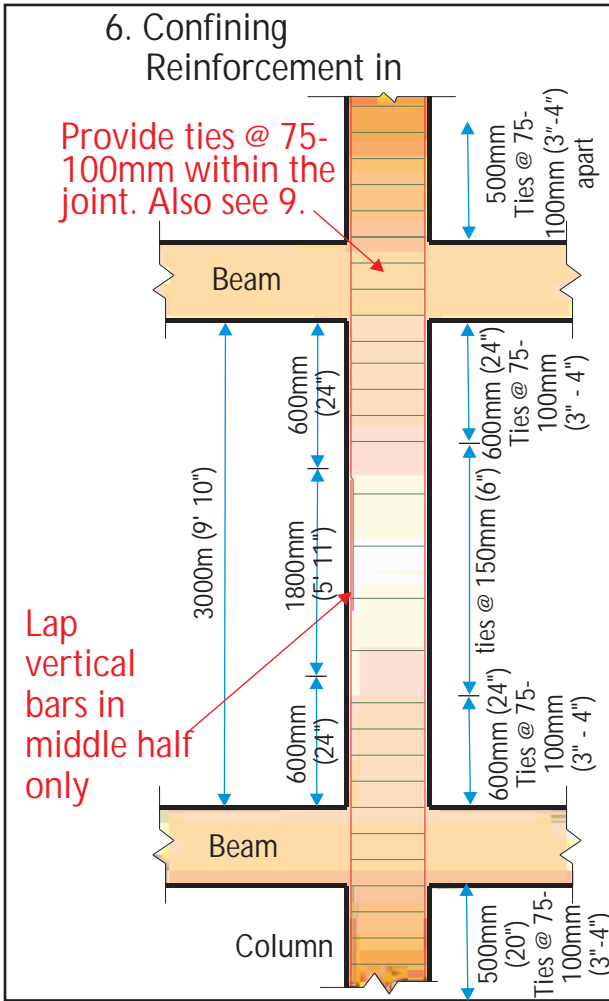

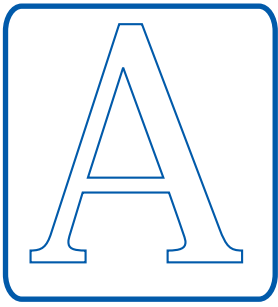

REFERENCES

1. A.S.Arya Dr. Principal Seismic Advisor, NDMA, Ministry of Home Affairs, Government of India, 2005, Guidelines for "Repair, Restoration and Retrofitting of Masonry Buildings in Earthquake Affected Areas of Jammu & Kashmir". and Guidelines for "Earthquake Resistant Reconstruction and New Construction of Masonry Buildings in Jammu and Kashmir State"
2. A.S.Arya Dr., Gujarat State Disaster Management Authority, Government of Gujarat. 2002, Guidelines for "Repair, Restoration and Retrofitting of Masonry Buildings in Kutchch Earthquake Affected Areas of Gujarat" and Guidelines for "Reconstruction and New Construction of Houses in Kutchch Earthquake Affected Areas of Gujarat".
3. Anand S. Arya Dr., 2007, "Earthquake Disaster Reduction: Masonry Buildings, Design and Construction"
4. BMTPC, 2000, "Guidelines for Damage Assessment and Post-Earthquake Action Part" II: "Repair and Retrofitting of Buildings in the Chomoli Earthquake Affected Areas",
5. BMTPC, 1999, "Guidelines Improving Earthquake Resistance of Housing",
6. BMPTC, Government of India, "Guide to Earthquake Safety for Uttaranchal"
7. BMTPC, 1997, Vulnerability Atlas of India
8. BMTPC, 1999-2000, "Guidelines Improving Wind/Cyclone Resistance of Housing
9. BMTPC, 2000, "Manual on Earthquake Safety for Garhwal" in Hindi language
10. DESAI, RAJENDRA, 1999, "Field Shake Table Program - A Sure Way of Confidence Building in Quake Resistant Building Technology", ASAG, (unpublished, available from the author)
11. ASAG,, 1994, "Earthquake and our House" in Marathi Language
12. ASAG, 1994, "Repaires and Retrofitting The Marathwada Houses"
13. NCPDP, 2006, "Manual for restoration and Retrofitting of Rural Vernacular Structures in Kashmir".
14. SCRC-UNDP, 1996, "Guidelines for Mitigating Damage to Dwellings due to Cyclones"
15. BRE 1988 "Cyclone-Resistant Houses for Developing Countries"
16. HUDCO, 2000 "Guidelines for Building Reconstruction in Cyclone Affected Areas in Orissa"
17. .Indian Society of Earthquake Technology, Roorkee, 1989, "A Manual of Earthquake Resistant Non-Engineered Construction"
18. "Improving Earthquake Resistance of Low Strength Masonry Buildings-Guidelines", IS:13828:1993
19. "Improving Earthquake Resistance of Earthen Buildings-Guidelines", IS:13827:1993
20. "Repair & Seismic Strengthening of Buildings-Guidelines", IS:13935:1993.
21. "Earthquake Resistant Design and Construction of Buildings Code of Practice" (Second Revision), IS:4326-1993
22. "Plain and reinforce concrete" IS 456:200
23. Ductile Detailing of Reinforced Concrete Structures subjected to Seismic Forces - Code of Practice" IS 13920-1993

About GOI-UNDP DRM Programme

Disaster Risk Management Programme is a multi donor funded, joint GOI-UNDP Programme being implemented in 169 multi hazard prone districts of 17 selected states, with the overall goal of sustainable reduction in disaster risk across India.

The main objectives of the programme are as follows:

- National Capacity Building to institutionalize the system for natural disaster risk management in the Ministry Of Home Affairs
- Environment building, education, awareness programmes and strengthening capacities at all levels in disaster risk management and sustainable recovery
- Multi hazard preparedness, response and mitigation plans for disaster risk management, developing and promoting policy frameworks at state and national level.

Urban Earthquake Vulnerability Reduction Project, a sub component of the GOI-UNDP DRM Programme is being implemented in 38 seismic prone cities of India falling either in Zone III, IV and V having a population of more than half a million. The project aims at sustainable reduction in earthquake risk in urban areas of India.

The major objectives of the project are

- Creating awareness on earthquake preparedness.
- Building up the capacity of professionals like architects, engineers and masons on earthquake resistant construction technology.
- Amending the building rules/Byelwas to ensure to structural safety in natural hazard prone areas.
- Build the capacity of local community by putting in place earthquake preparedness and response plan and training them in life supporting skills for effective response in a post disaster situation.
- Networking of knowledge and best practices across the cities on earthquake risk preparedness and mitigation.

About NCPDP

National Centre for Peoples'-Action in Disaster Preparedness (NCPDP)

NCPDP was created with a focus on disaster preparedness in October, 2000 at the time of Bhavnagar Earthquake in Gujarat. This was an outcome of seven years of post earthquake intervention by its two honorary directors in regions of Latur, Jabalpur and Chomoli in India. Later, it played a major role in rehabilitation as well as capacity building for long-term preparedness in Gujarat in the aftermath of Kutchch Earthquake, and also worked on capacity building and technology demonstration in the quake affected Kashmir.

NCPDP is one of a few technology-based organizations in the country with first-hand experience of working at the grass-roots. It has a firm belief that building capacity of people from within is the only way to mitigate disasters for a safer world. Hence, we believe that intervention by external agencies in the aftermath of a disaster is most needed to work in this direction. Skill up-gradation of building artisans should form the backbone of this approach.

NCPDP strives to bring viable, eco-friendly and sustainable technologies to help people reduce their vulnerability against future disasters. It strives to remain prepared for timely intervention in the aftermath of major disasters. It is continuing to work on disaster mitigation through (a) training of engineers and building artisans, (b) awareness & confidence building programs in communities, (c) preparing ready to use technical information for people, (d) research on structural behavior of masonry structures, and (e) building vulnerability studies in different parts of India. (f).vulnerability reduction through retrofitting (g). policy interventions.



For more information
National Disaster Management Division
Ministry of Home Affairs
Government of India
www.ndmindia.nic.in